

# SERVICE MANUAL

# FE-1A CHASSIS

MODEL	COMMANDER	DEST	CHASSIS NO.	MODEL	COMMANDER	DEST	CHASSIS NO.
<b>KV-25FX20A</b>	RM-887	Italian	SCC-Q32B-A	<b>KV-29FX20A</b>	RM-887	Italian	SCC-Q32A-A
<b>KV-25FX20B</b>	RM-887	French	SCC-Q33B-A	<b>KV-29FX20B</b>	RM-887	French	SCC-Q33A-A
<b>KV-25FX20D</b>	RM-887	AEP	SCC-Q31B-A	<b>KV-29FX20D</b>	RM-887	AEP	SCC-Q31A-A
<b>KV-25FX20E</b>	RM-887	Spanish	SCC-Q34B-A	<b>KV-29FX201D</b>	RM-887	AEP	SCC-Q31E-A
<b>KV-25FX20K</b>	RM-887	OIRT	SCC-Q36C-A	<b>KV-29FX20E</b>	RM-887	Spanish	SCC-Q34A-A
<b>KV-25FX20R</b>	RM-887	OIRT	SCC-Q36D-A	<b>KV-29FX201E</b>	RM-887	ESP	SCC-Q34E-A
				<b>KV-29FX20K</b>	RM-887	OIRT	SCC-Q36B-A
				<b>KV-29FX20R</b>	RM-887	OIRT	SCC-Q36A-A
				<b>KV-29FX20U</b>	RM-887	UK	SCC-Q35A-A

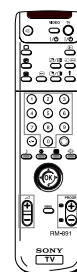

TRINITRON® COLOR TV  
**SONY®**



ITEM MODEL	Television System	Stereo System	Channel Coverage	Color System
<b>Italian</b>	B/G/H	GERMAN Stereo	ITALIA VHF : A-H2 (C) UHF : 21-69 PAL B/G/H VHF : E2-E12 UHF : E21-E69 CABLE TV (1) : S1-S41 CABLE TV (2) : S01-S05, M1-M10, U1-U10	PAL, SECAM NTSC4.43, NTSC3.58 (VIDEO IN)
<b>French</b>	B/G/H, D/K, L, I	GERMAN/NICAM Stereo	L VHF : F02-F10 UHF : F21-F60 CABLE : B-Q B/G/H VHF : E2-E12 UHF : E21-E69 CABLE TV (1) : S1-S41 CABLE TV (2) : S01-S05, M1-M10, U1-U10 ITALIA VHF : A-H2 (C) UHF : 21-69 I UHF : B21-B69	PAL, SECAM NTSC4.43, NTSC3.58 (VIDEO IN)
<b>AEP</b>	B/G/H	GERMAN Stereo	PAL B/G/H VHF : E2-E12 UHF : E21-E69 CABLE TV (1) : S1-S41 CABLE TV (2) : S01-S05, M1-M10, U1-U10 ITALIA VHF : A-H2 (C) UHF : 21-69 D/K VHF : R01-R12 UHF : R21-R69	PAL, SECAM NTSC4.43, NTSC3.58 (VIDEO IN)
<b>Spanish</b>	B/G/H, D/K	GERMAN/NICAM Stereo	PAL B/G VHF : E2-E12 UHF : E21-E69 CABLE TV (1) : S1-S41 CABLE TV (2) : S01-S05, M1-M10, U1-U10 ITALIA VHF : A-H2 (C) UHF : 21-69	PAL, SECAM NTSC4.43, NTSC3.58 (VIDEO IN)
<b>OIRT</b>	B/G/H, D/K	KV-25FX20K/29FX20K GERMAN/NICAM Stereo KV-25FX20R/29FX20R GERMAN Stereo	B/G/H VHF : E2-E12 UHF : E21-E69 CABLE TV (1) : S1-S41 D/K VHF : R01-R12 UHF : R21-R69	PAL, SECAM NTSC4.43, NTSC3.58 (VIDEO IN)
<b>UK</b>	I	NICAM Stereo	UHF : B21-B69	PAL NTSC4.43, NTSC3.58 (VIDEO IN)

MODEL	25FX20A	25FX20B	25FX20D	25FX20E	25FX20K	25FX20R	
<b>Power Consumption</b>	100W	100W	100W	100W	100W	100W	
MODEL	29FX20A	29FX20B	29FX20D	29FX20E	29FX20K	29FX20R	29FX20U
<b>Power Consumption</b>	120W	120W	120W	120W	120W	120W	150W

#### [PICTURE TUBE]

KV-25FX20 FD Trinitron  
Approx. 63cm (25 inches)  
(Approx. 59cm picture measured diagonally)  
110 degree deflection

KV-29FX20 FD Trinitron  
Approx. 72cm (29 inches)  
(Approx. 68cm picture measured diagonally)  
110 degree deflection

#### Input/Output Terminals



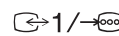

#### [REAR]

 21-pin Euro connector (CENELEC standard).  
- Inputs for Audio and Video signals.  
- Inputs for RGB.  
- Outputs of TV Video and Audio signals.

 21-pin Euro connector.  
- inputs for Audio and Video signals.  
- inputs for S Video.  
- outputs for Audio and Video signals (selectable).

 Phono Jack  
- Outputs for Audio Signals

#### [FRONT]

 3 Video input - phono jack  
 3 Audio inputs - phono jacks  
 S Video input - 4 pin din  
 Headphone jacks : stereo minijack

Sound output 2 x 14W (Music Power)  
Subwoofer 30W (Music Power)  
Power requirements 220 - 240V  
Dimensions  
KV-25FX20 Approx 655x509x476mm (w/h/d)  
KV-29FX20 Approx 746x569x516mm (w/h/d)  
Weight  
KV-25FX20 Approx 37kg  
KV-29FX20 Approx 47.5kg  
Supplied accessories RM-887 Remote Commander (1)  
IEC designated R6 battery (2)  
Other features NICAM\*, FASTEXT, TOPTXT  
\*(KV-25FX20B/25FX20E/25FX20K/  
KV-29FX20B/29FX20E/29FX20K/  
KV-29FX20U only)

**[RM-887]**

Remote control system    Infrared control  
 Power requirements        3V dc  
                                       2 batteries IEC designation  
                                       R6 (size AA)  
 Dimensions                    Approx 44x209x23mm (w/h/d)  
 Weight                            Approx 89g (Not including battery)

**Design and specifications are subject to change without notice.**

Model Name Item	KV-25FX20A	KV-25FX20B	KV-25FX20D	KV-25FX20E	KV-25FX20K	KV-25FX20R	KV-29FX20U
	KV-29FX20A	KV-29FX20B	KV-29FX20D	KV-29FX20E	KV-29FX20K	KV-29FX20R	
Pal Comb	OFF	OFF	OFF	OFF	OFF	OFF	OFF
PIP	OFF	OFF	OFF	OFF	OFF	OFF	OFF
RGB Priority	OFF	ON	ON	ON	OFF	OFF	OFF
Woofers Box	ON	ON	ON	ON	ON	ON	ON
Scart 1	ON	ON	ON	ON	ON	ON	ON
Scart 2	ON	ON	ON	ON	ON	ON	ON
Front in (3)	ON	ON	ON	ON	ON	ON	ON
Scart 4	OFF	OFF	OFF	OFF	OFF	OFF	OFF
Projector	OFF	OFF	OFF	OFF	OFF	OFF	OFF
AKB in 16:9 mode	ON	ON	ON	ON	ON	ON	ON
Norm B/G	ON	ON	ON	ON	ON	ON	OFF
Norm I	OFF	ON	OFF	OFF	OFF	OFF	ON
Norm D/K	OFF	ON	OFF	ON	ON	ON	OFF
Norm AUS	OFF	OFF	OFF	OFF	OFF	OFF	OFF
Norm L	OFF	ON	OFF	OFF	OFF	OFF	OFF
Norm SAT	OFF	OFF	OFF	OFF	OFF	OFF	OFF
Norm M	OFF	OFF	OFF	OFF	OFF	OFF	OFF
Teletext	ON	ON	ON	ON	ON	ON	ON
Nicam Stereo	OFF	ON	OFF	ON	ON	OFF	ON
Language Preset	Italian	French	German	Spanish	OIRT	OIRT	English

**WARNING (KV-29FX20U only)**

The flexible mains lead is supplied connected to a **B.S. 1363** fused plug having a fuse of **5 AMP** capacity. Should the fuse need to be replaced, use a **5 AMP FUSE** approved by **ASTA** to **BS 1362**, ie one that carries the  mark.

IF THE PLUG SUPPLIED WITH THIS APPLIANCE IS NOT SUITABLE FOR THE OUTLET SOCKETS IN YOUR HOME, IT SHOULD BE CUT OFF AND AN APPROPRIATE PLUG FITTED. THE PLUG SEVERED FROM THE MAINS LEAD MUST BE DESTROYED AS A PLUG WITH BARED WIRES IS DANGEROUS IF ENGAGED IN A LIVE OUTLET SOCKET.

When an alternative type of plug is used it should be fitted with a **5 AMP FUSE**, otherwise the circuit should be protected by a **5 AMP FUSE** at the distribution board.

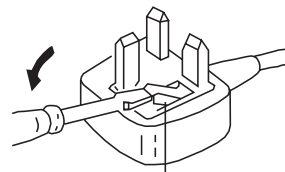

How to replace the fuse.  
 Open the fuse compartment with a screwdriver blade and replace the fuse.

21 pin connector ( ↔ 1/ →⊙⊙⊙ , ↔ 2/ →S )

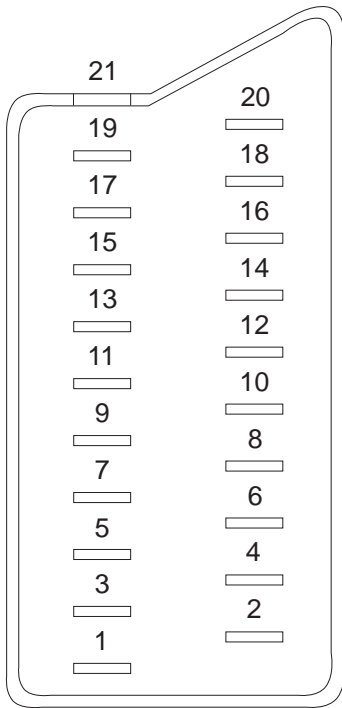
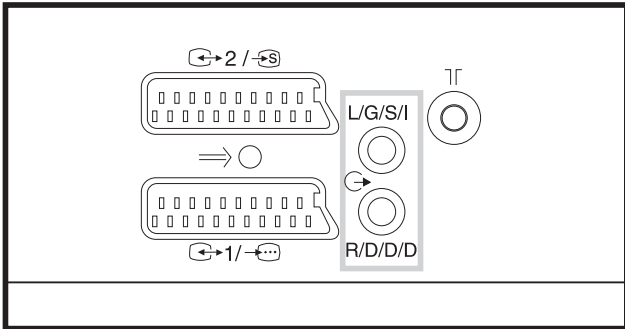

Pin No	1	2	4	Signal	Signal level
1	○	○	○	Audio output B (right)	Standard level : 0.5V rms Output impedance : Less than 1kohm*
2	○	○	○	Audio output B (right)	Standard level : 0.5V rms Output impedance : More than 10kohm*
3	○	○	○	Audio output A (left)	Standard level : 0.5V rms Output impedance : Less than 1kohm*
4	○	○	○	Ground (audio)	
5	○	○	○	Ground (blue)	
6	○	○	○	Audio input A (left)	Standard level : 0.5V rms Output impedance : More than 10kohm*
7	○	●	●	Blue input	0.7 +/- 3dB, 75 ohms positive
8	○	○	○	Function select (AV control)	High state (9.5-12V) : Part mode Low state (0-2V) : TV mode Input impedance : More than 10K ohms Input capacitance : Less than 2nF
9	○	○	○	Ground (green)	
10	○	○	○	Open	
11	○	●	●	Green	Green signal : 0.7 +/- 3dB, 75 ohms, positive
12	○	○	○	Open	
13	○	○	○	Ground (red)	
14	○	○	○	Ground (blanking)	
15	○	-	-	Red input	0.7 +/- 3dB, 75 ohms, positive
	-	○	○	(S signal Chroma input)	0.3 +/- 3dB, 75 ohms, positive
16	○	●	●	Blanking input (Ys signal)	High state (1-3V) Low state (0-0.4V) Input impedance : 75 ohms
17	○	○	○	Ground (video output)	
18	○	○	○	Ground (video input)	
19	○	○	○	Video output	1V +/- 3dB, 75ohms, positive sync 0.3V (-3+10dB)
20	○	-	-	Video input	1V +/- 3dB, 75ohms, positive sync 0.3V (-3+10dB)
	-	○	○	Video input Y (S signal)	1V +/- 3dB, 75ohms, positive sync 0.3V (-3+10dB)
21	○	○	○	Common ground (plug, shield)	

○ Connected ● Not Connected (open) \* at 20Hz - 20kHz

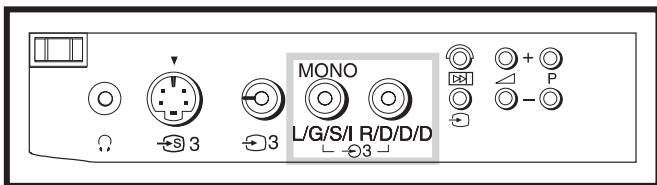

Pin No.	Signal	Signal Level
1	Ground	
2	Ground	
3	Y (S signal) input	1V ± 3dB 75 ohm, positive Sync. 0.3V -3 + 10dB
4	C (S signal) input	0.3V ± 3dB 75 ohm, positive Sync.

# TABLE OF CONTENTS

<i>Section</i>	<i>Title</i>	<i>Page</i>	<i>Section</i>	<i>Title</i>	<i>Page</i>
	Warning and Caution	.....3	<b>4. CIRCUIT ADJUSTMENTS</b>		
	FE-1A Self Diagnostic Software	.....6	4-1. Electrical Adjustments		.....20
<b>1. GENERAL</b>			4-2. Test Mode 2		.....23
	Overview of Remote Control Buttons	.....7	<b>5. DIAGRAMS</b>		
	Manually Tuning the TV	.....7	5-1. Block Diagram (1)		.....25
	Fine Tuning Channels	.....8	Block Diagram (2)		.....29
	Adjusting the Picture	.....8	5-2. Circuit Board Location		.....32
	Adjusting the Sound	.....9	5-3. Schematic Diagrams and Printed Wiring Boards		.....32
	Using the Sleep Timer	.....9	* S1 Board		.....33
	Viewing Teletext	.....10	* F Board		.....34
	Using Optional Equipment	.....10	* K Board		.....36
	Troubleshooting	.....11	* H Board		.....37
	Specifications	.....11	* A Board		.....41
<b>2. DISASSEMBLY</b>			* VM Board		.....46
2-1. Rear Cover Removal		.....12	* C Board		.....50
2-2. Chassis Assy Removal		.....12	5-4. Semiconductors		.....51
2-3. Service Position		.....13	5-5. IC Blocks		.....53
2-4. H Board Removal		.....13	<b>6. EXPLODED VIEWS</b>		
2-5. S1 Board Removal		.....13	6-1. Chassis		.....54
2-6. Picture Tube Removal		.....14	6-2. Picture Tube		.....56
2-7. Removal and Replacement of the Main - Bracket bottom plates		.....15	<b>7. ELECTRICAL PARTS LIST</b>		.....57
<b>3. SET-UP ADJUSTMENTS</b>					
3-1. Beam Landing		.....16			
3-2. Convergence		.....17			
3-3. Focus		.....19			
3-4. White Balance		.....19			

## CAUTION

**SHORT CIRCUIT THE ANODE OF THE PICTURE TUBE AND THE ANODE CAP TO THE METAL CHASSIS, CRT SHIELD, OR THE CARBON PAINTED ON THE CRT, AFTER REMOVAL OF THE ANODE CAP**

## WARNING !!

AN ISOLATING TRANSFORMER SHOULD BE USED DURING ANY SERVICE WORK TO AVOID POSSIBLE SHOCK HAZARD DUE TO LIVE CHASSIS. THE CHASSIS OF THIS RECEIVER IS DIRECTLY CONNECTED TO THE POWER LINE.

## SAFETY-RELATED COMPONENT WARNING !!

COMPONENTS IDENTIFIED BY SHADING AND MARKED  $\Delta$  ON THE SCHEMATIC DIAGRAMS, EXPLODED VIEWS AND IN THE PARTS LIST ARE CRITICAL FOR SAFE OPERATION. REPLACE THESE COMPONENTS WITH SONY PARTS WHOSE PART NUMBERS APPEAR AS SHOWN IN THIS MANUAL OR IN SUPPLEMENTS PUBLISHED BY SONY.

## ATTENTION

**APRES AVOIR DECONNECTE LE CAP DE L'ANODE, COURT-CIRCUITER L'ANODE DU TUBE CATHODIQUE ET CELUI DE L'ANODE DU CAP AU CHASSIS METALLIQUE DE L'APPAREIL, OU AU COUCHE DE CARBONE PEINTE SUR LE TUBE CATHODIQUE OU AU BLINDAGE DU TUBE CATHODIQUE.**

## ATTENTION !!

AFIN D'EVITER TOUT RISQUE D'ELECTROCUTION PROVENANT D'UN CHASSIS SOUS TENTION, UN TRANSFORMATEUR D'ISOLEMENT DOIT ETRE UTILISÉ LORS DE TOUT DÉPANNAGE. LE CHASSIS DE CE RÉCEPTEUR EST DIRECTMENT RACCORDÉ À L'ALIMENTATION SECTEUR.

## ATTENTION AUX COMPOSANTS RELATIFS À LA SÉCURITÉ !!

LES COMPOSANTS IDENTIFIÉS PAR UNE TRAME ET PAR UNE MARQUE  $\Delta$  SUR LES SCHÉMAS DE PRINCIPE, LES VUES EXPLOSÉES ET LES LISTES DE PIÈCES SONT D'UNE IMPORTANCE CRITIQUE POUR LA SÈCURITÉ DU FONCTIONNEMENT, NE LES REMPLACER QUE PAR DES COMPOSANTS SONY DONT LE NUMÈRE DE PIÈCE EST INDIQUÉ DANS LE PRÉSENT MANUEL OU DANS DES SUPPLÈMENTS PUBLIÉS PAR SONY.

## FE-1A SELF DIAGNOSTIC SOFTWARE

The identification of errors within the FE-1A chassis is triggered in one of two ways :- 1: Busy or 2: Device failure to respond to IIC. In the event of one of these situations arising the software will first try to release the bus if busy (Failure to do so will report with continuous flashing LED) and then communicate with each device in turn to establish if a device is faulty. If a device is found to be faulty the relevant device number will be displayed through the LED (Series of flashes which must be counted) See Table 1., non fatal errors are reported using this method. Each time the software detects an error it is stored within the NVM. See Table 2.

**Table 1**

ERROR	LED ERROR COUNT
No error	00
Not allowed (may be confused with Sircs response flash!)	01
Protection circuit trip < ANY TIME >	02
Reserved	03
No vertical sync	04
AKB	05
IIC bus clock and/or data lines low at Power ON	06
NVM no IIC bus acknowledge at Power ON	07
Jungle controller no IIC acknowledge at Power ON	08
Tuner no acknowledge at Power ON	09
Sound processor no acknowledge at Power ON	10

### Flash Timing Example : e.g. error number 3

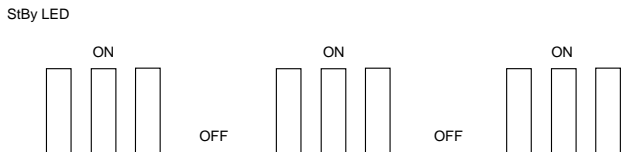

### How to enter into Table 2

1. Turn on the main power switch of the TV set and enter into the 'Standby Mode'.
2. Press the following sequence of buttons on the Remote Commander.

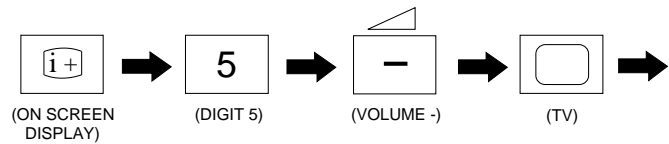

3. The following table will be displayed indicating the error count.

**Table 2**

Error	Times
2	-
3	-
4	-
5	-
6	-
7	-
8	-
9	-
10	-

**Note:** To clear the error count data press '80' on the Remote commander.

# SECTION 1 GENERAL

The operating instructions mentioned here are partial abstracts from the Operating Manual. The page numbers of the Operating Instruction Manual remain as in the manual.

## Getting Started - Overview

### Overview of Remote Control Buttons

**Muting the Sound**  
Press to mute TV sound. Press again to restore the sound.

**Displaying On Screen Information**  
Press to display all on-screen indications. Press again to cancel.

**Selecting channels**  
Press to select channels.

For double-digit programme numbers, e.g. 23, press -/– first, then the buttons 2 and 3. If you enter an incorrect first digit, this should be corrected by entering another digit (0-9) and then selecting -/– button again to enter the programme number of your choice.

**Selecting TV mode**  
Press to switch off Teletext or video input.

**Selecting Teletext**  
Press to switch on Teletext.

**Selecting Sound mode**  
Press to change the sound mode.

**Selecting Picture mode**  
Press to change the picture mode.

**Adjusting TV Volume**  
Press to adjust the volume of the TV.

**To Temporarily Switch Off TV**  
Press to temporarily switch off TV (the standby indicator on TV lights up). Press again to switch on TV from standby mode. *To save energy we recommend switching off completely when TV is not in use.*  
**⚠** After 15-30 minutes without a TV signal and without any button being pressed, the TV switches automatically into standby mode.

**Selecting Input source**  
Press repeatedly until the desired input symbol of the source appears on the TV screen.

**Back to the channel last watched**  
Press to watch the last channel selected (watched for at least 5 seconds).

**Displaying the menu system**  
Press to display the menu on the TV screen. Press again to remove the menu display from the TV screen.

**Menu selection**  
 ▲ **SONY** scroll Up  
 ▼ **SONY** scroll Down  
 ◀ Previous menu or selection  
 ▶ Next menu or selection  
**OK** Confirms your selection

**Selecting Screen format**  
Press to view programmes in 16:9 mode. Press again to return to 4:3 mode.

This button only works in Teletext mode.

**Selecting channels**  
Press to select the next or previous channel.

## Advanced Operation - Advanced Presetting

### Manually Tuning the TV

**i** Use this function to preset channels or a video input source one by one to the programme order of your choice.

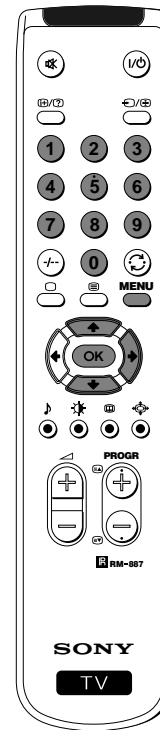

- Press the **MENU** button on the remote control to display the menu on the TV screen.
- Press the **▼** button to select the symbol, then press the **▶** button to enter to the **SET UP** menu.
- Press the **▼** button to select **MANUAL PROGRAMME**, then press the **▶** button.
- With the cursor highlighting **PROGRAMME**, press the **▶** button and then, press the **▲** or **▼** button to select on which programme number you want to preset a channel. Press the **OK** button.
- Press the **▼** button to select **CHANNEL**, then press the **▶** button. Press **▲** or **▼** button to select the channel tuning, "C" for terrestrial channels or "S" for cable channels. Press the **▶** button.
- Press the number buttons to enter the channel number of the TV Broadcast or press the **▲** or **▼** button to search for the next available channel. If you do not wish to store this channel, press the **▲** or **▼** button to continue searching for the desired channel.
- If this is the desired channel you wish to store, press the **OK** button and then, with the cursor highlighting **CONFIRM**, press the **OK** button again.

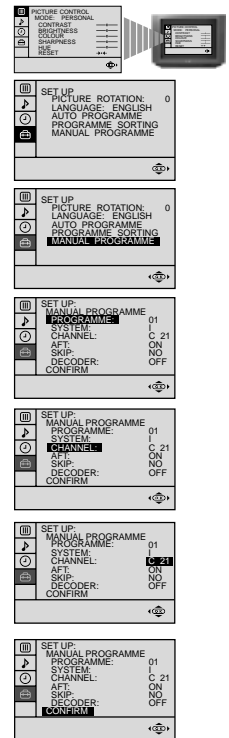

- Repeat steps 4 to 7 if you wish to store more channels.
- Press the **MENU** button to exit and return to the normal TV screen.

Your TV is now ready for use.

**i** Besides TV functions, all coloured buttons are also used for Teletext operation. For more details, please refer to the "Teletext" section of this instruction manual.

## Fine Tuning Channels

- 1 Normally, the automatic fine tuning (AFT) function is operating. If the picture is distorted, however, you can manually fine tune the TV to obtain a better picture reception.

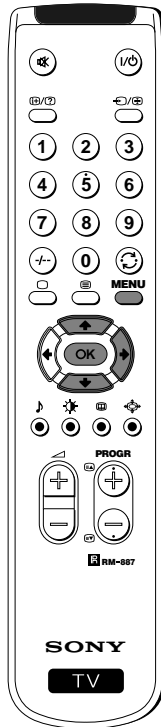

- 1 Select the channel (TV Broadcast) you wish to fine tune, then press the **MENU** button on the remote control to display the menu on the TV screen.
- 2 Press the **▼** button to select the **☰** symbol, then press the **▶** button to enter to the **SET UP** menu.
- 3 Press the **▼** button to select **MANUAL PROGRAMME**, then press the **▶** button.
- 4 Press the **▼** button to select **AFT**, then press the **▶** button.
- 5 Press the **▼** or **▲** button to adjust the fine tuning (-15 to +15), then press the **OK** button.
- 6 With the cursor highlighting **CONFIRM**, press the **OK** button to store.
- 7 Press the **MENU** button to exit and return to the normal TV screen.
- 8 Repeat steps 1 to 7 to fine tune other channels.

Your TV is now ready for use.

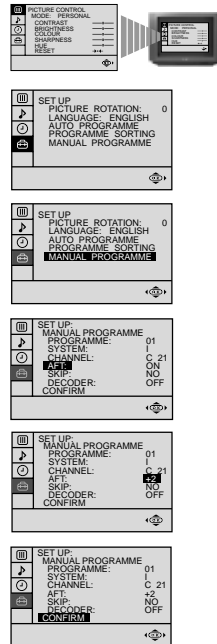

## Adjusting the Picture

- 1 Although the picture is adjusted at the factory, you can modify it to suit your own taste.

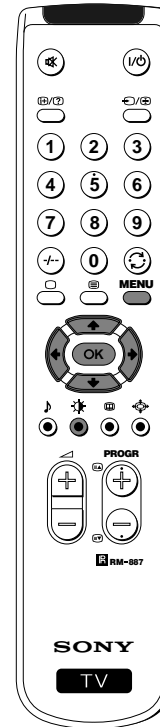

- 1 Press the **MENU** button on the remote control to display the menu on the TV screen.
- 2 Press the **▶** button to enter to the **PICTURE CONTROL** menu.
- 3 Press the **▼** or **▲** button to select the item you wish to change.
- 4 With the cursor highlighting the item you wish to change, press the **▶** button.  
(Refer to the table below for the effect of each control).
- 5 Press the **▼/▲** or **◀/▶** button to alter the selected item, then press the **OK** button to store the new adjustment.
- 6 Repeat steps 3 to 5 to alter the other items.
- 7 Press the **MENU** button to exit and return to the normal TV screen.

PICTURE CONTROL	OPERATION / EFFECT
MODE	<ul style="list-style-type: none"> <li>▼ PERSONAL (for individual settings)</li> <li>▼ LIVE (for live broadcast programmes)</li> <li>▼ MOVIE (for films)</li> </ul>
CONTRAST	Less ◀ ▶ More
BRIGHTNESS*	Darker ◀ ▶ Brighter
COLOUR*	Less ◀ ▶ More
SHARPNESS*	Softer ◀ ▶ Sharper
HUE**	Greenish ◀ ▶ Reddish
RESET	Resets picture to the factory preset levels.

\* Can be only altered if PERSONAL MODE is selected.  
\*\* Only available for NTSC colour signal (e.g. US video tapes).

### Changing Picture Mode Quickly

- 1 Press the **☰** button on the remote control to directly access the **PICTURE MODE**.
- 2 Press the **▼** button to select your desired picture mode (**PERSONAL**, **LIVE** or **MOVIE**), then press the **OK** button.

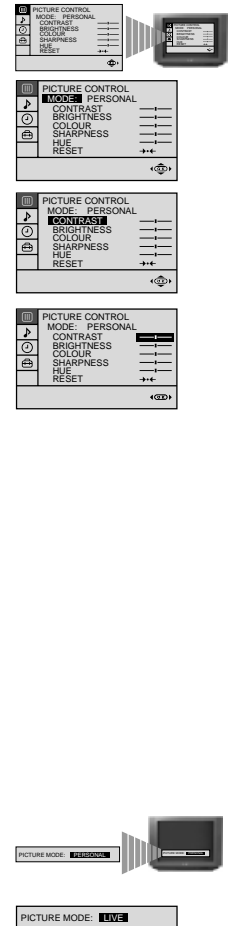



## Advanced Operation - Advanced TV Operation

### Adjusting the Sound

① Although the sound is adjusted at the factory, you can modify it to suit your own taste.

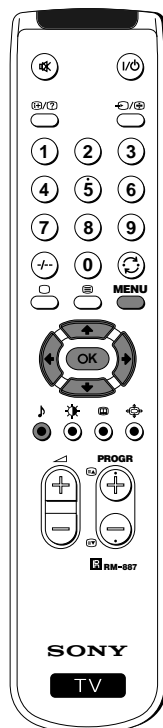

- 1 Press the **MENU** button on the remote control to display the menu on the TV screen.
  - 2 Press the **▼** button to select the **▶** symbol, then press the **▶** button to enter to the **SOUND CONTROL** menu.
  - 3 Press the **▼** or **▲** button to select the item you wish to change.
  - 4 With the cursor highlighting the item you wish to change, press the **▶** button.  
(Refer to the table below for the effect of each control).
- | SOUND CONTROL                 | OPERATION / EFFECT  |
|-------------------------------|---|
| MODE                          | <ul style="list-style-type: none"> <li>▼ PERSONAL (for individual settings)</li> <li>▼ JAZZ</li> <li>▼ POP</li> <li>▼ ROCK</li> </ul>   |
| TREBLE*                       | Less ◀ ▶ More   |
| BASS*                         | Less ◀ ▶ More   |
| BALANCE                       | Left ◀ ▶ Right  |
| DUAL SOUND                    | <ul style="list-style-type: none"> <li>• For a stereo broadcast:                             <ul style="list-style-type: none"> <li>▼ MONO</li> <li>▲ STEREO</li> </ul> </li> <li>• For a bilingual broadcast:                             <ul style="list-style-type: none"> <li>▼ A for channel 1</li> <li>▲ B for channel 2</li> </ul> </li> </ul> |
| DSP (Digital sound Processor) | ON ◀ ▶ OFF  |
| RESET                         | ◀▶ Resets sound to the factory preset levels.   |
- \* Can be only altered if PERSONAL MODE is selected.
- 5 Press the **▼/▲** or **◀/▶** button to alter the selected item, then press the **OK** button to store the new adjustment.
  - 6 Repeat steps 3 to 5 to alter the other items.
  - 7 Press the **MENU** button to exit and return to the normal TV screen.

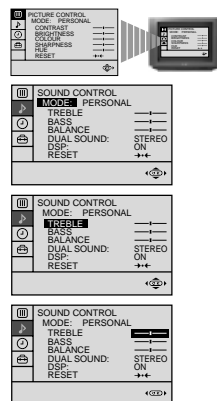

### Changing Sound Mode Quickly

- 1 Press the **▶** button on the remote control to access directly to the **SOUND MODE**.
- 2 Press the **▼** button to select your desired sound mode (**PERSONAL**, **JAZZ**, **POP** or **ROCK**), then press the **OK** button.

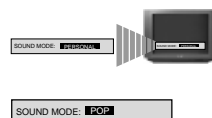

## Advanced Operation - Advanced TV Operation

### Using the Sleep Timer

① You can select a time period for the TV to switch itself automatically into the standby mode.

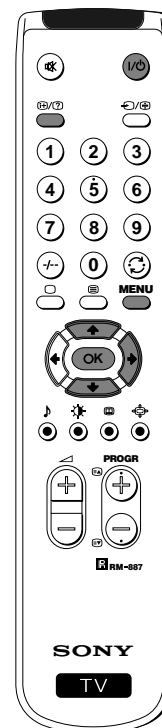

- 1 Press the **MENU** button on the remote control to display the menu on the TV screen.
- 2 Press the **▼** button to select the **⌚** symbol, then press the **▶** button to enter to the **TIMER** menu.
- 3 With the cursor highlighting **OFF TIMER**, press the **▶** button.
- 4 Press the **▼** or **▲** button to set the time period delay
  - ▲ OFF
  - 0:15 min.
  - 0:30 min.
  - ...
  - ...
  - ▼ 4:00 hours
- 5 Press the **OK** button.
- 6 Press the **MENU** button to exit and return to the normal TV screen.

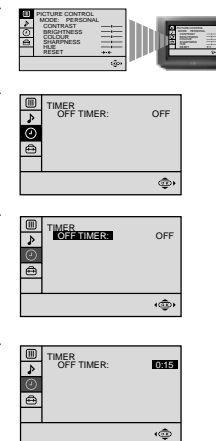

🕒 One minute before the TV switches into standby mode, the time remaining is displayed on the TV screen automatically.

- Notes:**
- When watching the TV, press the **⏻** button to display the time remaining.
  - To return to normal operation from standby mode, press the **|/⏻** button.

## Teletext

### Viewing Teletext

- ① Teletext is an information service transmitted by most TV stations.
- ⚠ Make sure to use a TV channel with a strong signal, otherwise teletext errors may occur.

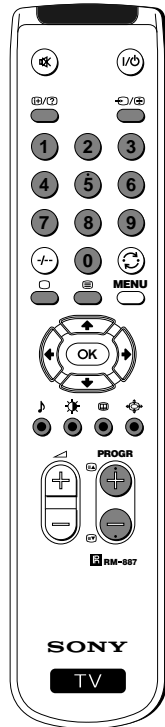

### Selecting Teletext

- 1 Select the TV channel which carries the teletext service you wish to view.
- 2 Press the button on the remote control to switch on the teletext.
- 3 Input three digits for the page number, using the numbered buttons on the remote control. (if you have made a mistake, type in any three digits and then, re-enter the correct page number).
- 4 Press the button to switch off teletext.



### Using other Teletext functions

TO	PRESS THE BUTTON
Access the next or preceding page	for next page or  for the preceding page
Superimpose teletext on to the TV	Press  again to cancel teletext mode.
Freeze a teletext page	Press  again to cancel the freeze.
Reveal concealed information (e.g. answer to a quiz)	Press  again to cancel.



### Using Fastext

- ① Fastext lets you access pages with one button stroke.
- When Fastext is broadcast, a colour coded menu appears at the bottom of the teletext page. Press the colour button (red, green, yellow or blue) on the remote control to access the corresponding page.

## Optional Connections

### Using Optional Equipment

- ① You can connect optional audio or video equipment to your TV, such as a VCR, a camcorder or a video game as shown below.

### Select and View the Input Signal

- 1 Connect your equipment to the designated TV socket.
- 2 Press the button repeatedly on your remote control until the correct input symbol appears on the TV screen.

Symbol	Input signals
	• Audio/video input signal through the Euro AV connector <b>F</b>
	• RGB input signal through the Euro AV connector <b>F</b>
	• Audio/video input signal through the Euro AV connector <b>E</b>
	• S video input signal through the Euro AV connector <b>E</b>
	• Video input signal through the phono socket <b>C</b> and Audio input signal through <b>D</b>
	• S video input signal through the socket <b>B</b> and Audio input signal through <b>D</b> .

- 3 Switch on the connected equipment.
- 4 To return to normal TV picture, press the button on the remote control.

**Note:** To avoid picture distortion, do not connect equipment to the **B** and **E** connectors at the same time.

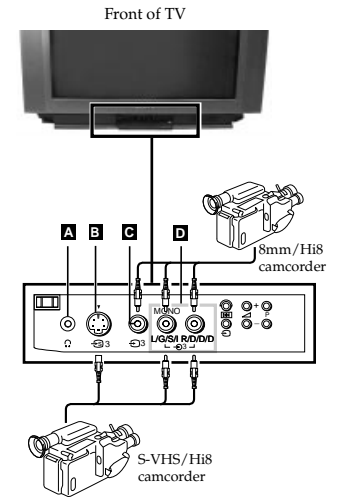

### Additional Information

**Connecting a VCR**  
Plug in VCR to the socket **F** on the rear of the TV set. We recommend you tune in the VCR signal to TV programme number '0' using the section "Manually Tuning the TV" of this instruction manual.

**Connecting Headphones**  
Plug in your headphones to the socket **A** on the front of the TV set.

**Connecting Decoders**  
Plug in decoders to the socket **F** on the rear of the TV.

**Connecting to External Audio Equipment**  
Plug in your Hi-Fi equipment to the **G** sockets on the rear of the TV if you wish to amplify the audio output from the TV.

\* "PlayStation" is a product of Sony Computer Entertainment, Inc.  
\* "PlayStation" is a trademark of Sony Computer Entertainment, Inc.

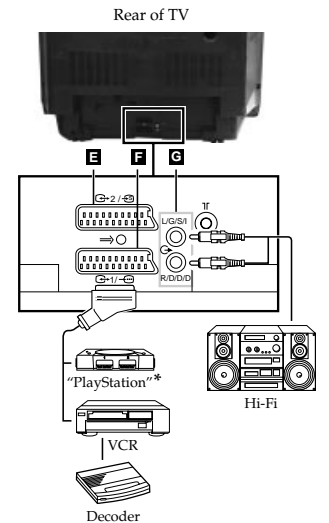











Optional Connections | 21

## Additional Information

### Troubleshooting

Here are some simple solutions to the problems which may affect the picture and sound.

Problem	Solution
No picture (screen is dark), no sound	<ul style="list-style-type: none"> <li>Plug the TV in.</li> <li>Press the  button on the front of TV.</li> <li>If the  indicator is on, press  button or a programme number button on the remote control.</li> <li>Check the aerial connection.</li> <li>Check that the selected video source is on.</li> <li>Turn the TV off for 3 or 4 seconds and then turn it on again using the  button on the front of the TV.</li> </ul>
Poor or no picture (screen is dark), but good sound	<ul style="list-style-type: none"> <li>Using the MENU system, select the Picture Adjustment display. Adjust the brightness, picture and colour balance levels.</li> <li>From the Picture Adjustment display select RESET to return to the factory settings.</li> </ul>
Poor picture quality when watching a RGB video source.	<ul style="list-style-type: none"> <li>Press the  button repeatedly on the remote control until the RGB symbol  is displayed on the screen.</li> </ul>
Good picture, no sound	<ul style="list-style-type: none"> <li>Press the  +/- button on the remote control.</li> <li>If  is displayed on the screen, press the  button on the remote control.</li> </ul>
No colour on colour programmes	<ul style="list-style-type: none"> <li>Using the MENU system, select the Picture Adjustment display. Adjust the colour balance.</li> <li>From the Picture Adjustment display select RESET to return to the factory settings.</li> </ul>
Distorted picture when changing programmes or selecting teletext	<ul style="list-style-type: none"> <li>Turn off any equipment connected to the 21 pin Euro connector on the rear of the TV.</li> </ul>
Noisy picture when viewing TV channel	<ul style="list-style-type: none"> <li>Adjust Fine Tuning to obtain better picture reception.</li> </ul>
Remote control does not function	<ul style="list-style-type: none"> <li>Replace the batteries.</li> </ul>
The standby indicator  on the TV flashes.	<ul style="list-style-type: none"> <li>Contact to your nearest Sony service centre.</li> </ul>

-  • If you continue to have these problems, have your TV serviced by qualified personnel.  
• NEVER open the casing yourself.

## Additional Information

### Specifications

#### TV system

I

#### Colour system

PAL  
NTSC 3.58, 4.43 (only Video In)

#### Channel coverage

UHF: B21-B69

#### Picture tube

Flat Display Trinitron  
Approx. 72 cm (29 inches) (Approx. 68 cm picture measured diagonally), 104° deflection

#### Rear Terminals

 21-pin Euro connector (CENELEC standard) including audio/video input, RGB input, TV audio/video output

 21-pin Euro connector (CENELEC standard) including audio/video input, S-video input, monitor audio/video output

 Audio outputs - phono jacks

#### Front Terminals

 3 video input - phono jack

 3 audio inputs - phono jacks

 3 S video input - 4 pin DIN

 Headphones jack - minijack stereo

#### Sound output

2x7 W + 1x15 W (RMS)

#### Power consumption

150 W

#### Standby Power consumption

0.5 W

#### Dimensions (w x h x d)

Approx. 746 x 569 x 516 mm

#### Weight

Approx. 47.5 kg

#### Accessories supplied

1 Remote Control (RM-887)  
2 Batteries (IEC designated)

#### Other features

TELETEXT, Fasttext, TOPtext  
NICAM Stereo  
Sleep Timer  
Smartlink

Design and specifications are subject to change without notice.

## SECTION 2 DISASSEMBLY

### 2-1. REAR COVER REMOVAL

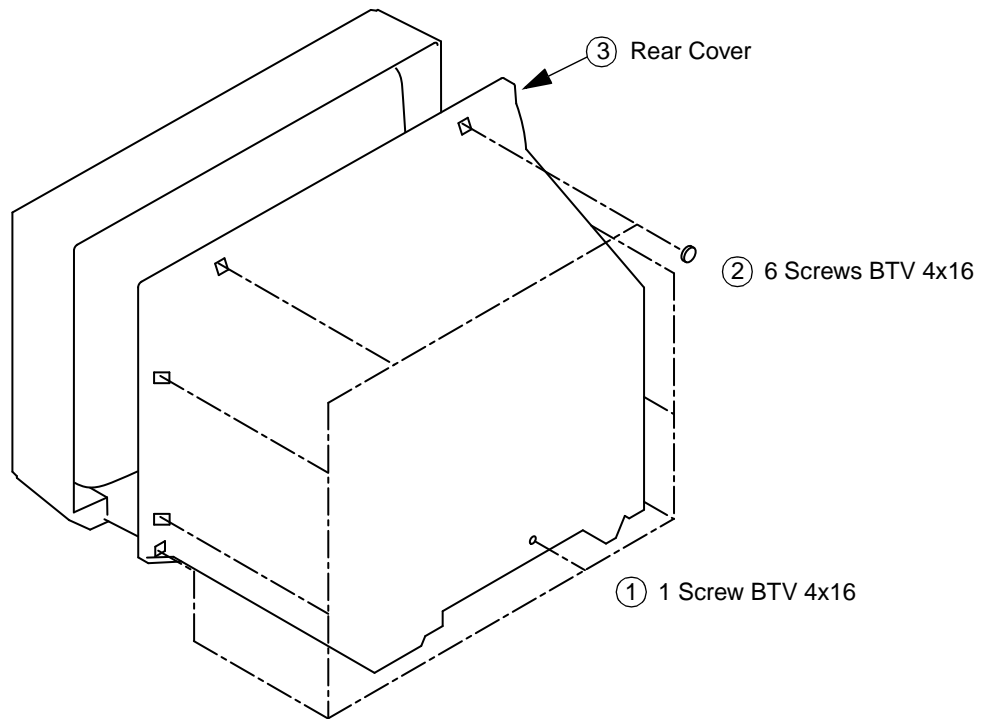

### 2-2. CHASSIS ASSY REMOVAL

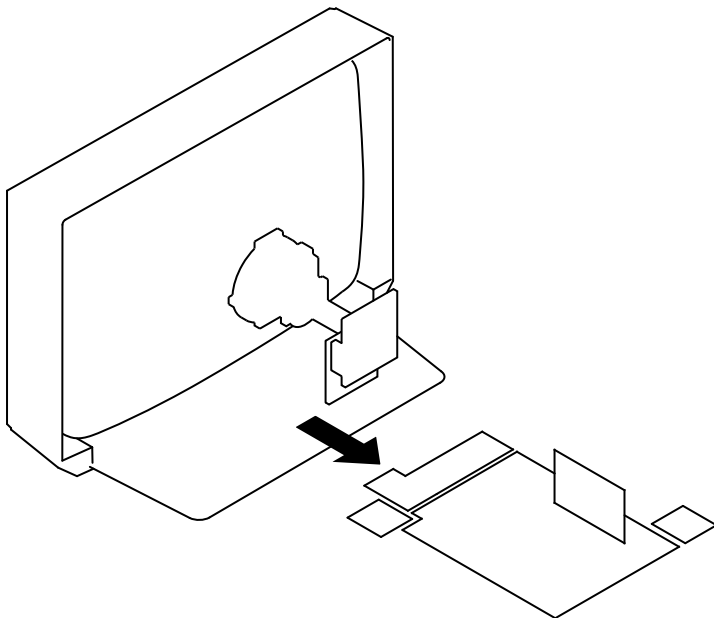

### 2-3. SERVICE POSITION

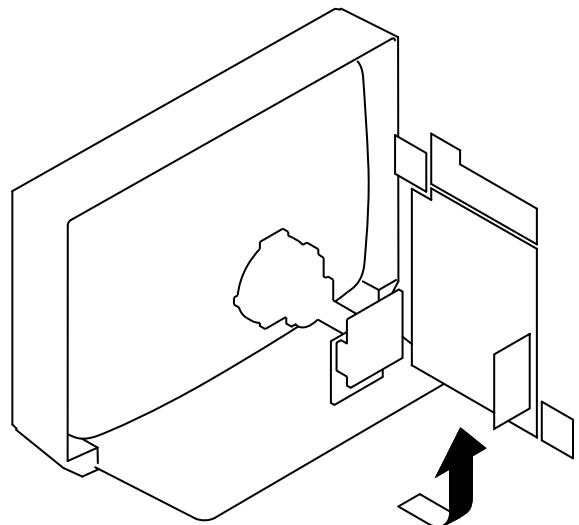

## 2-4. H BOARD REMOVAL

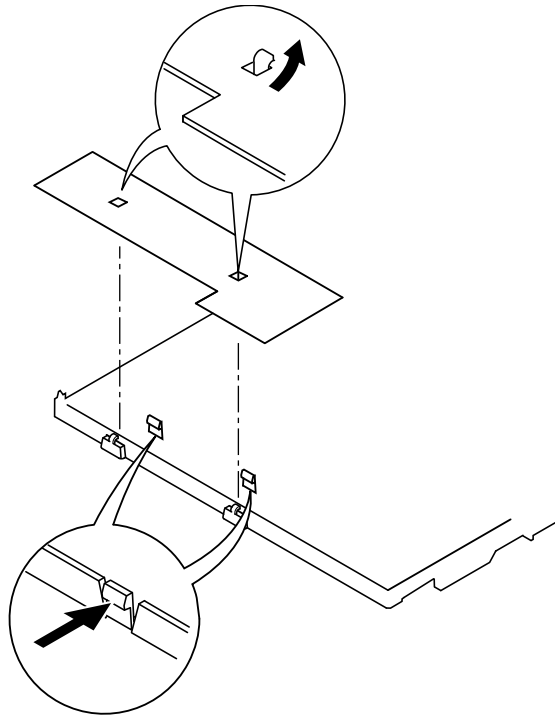

To release, push the claws in the direction of the arrow as indicated.

## 2-5. S1 BOARD REMOVAL

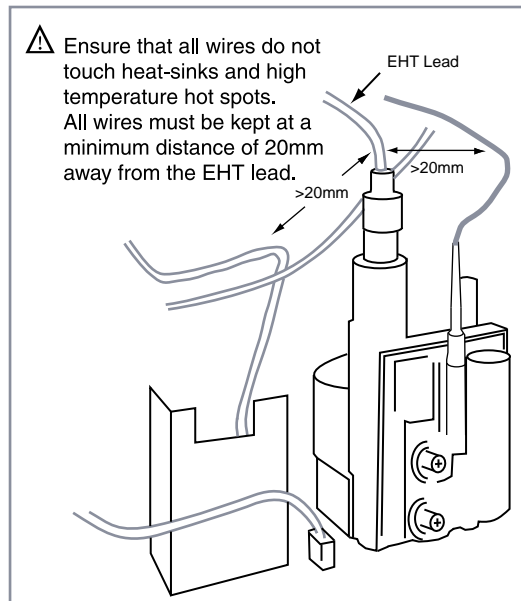
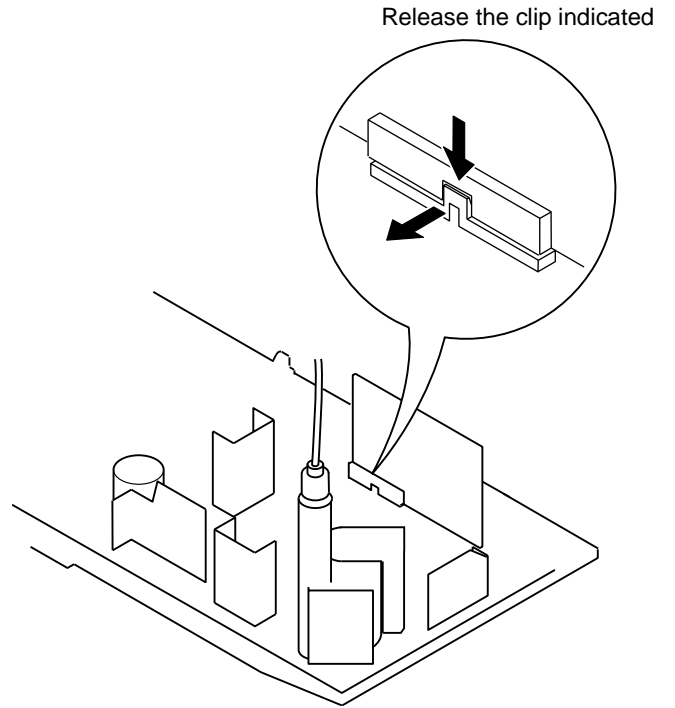

## 2-6. PICTURE TUBE REMOVAL

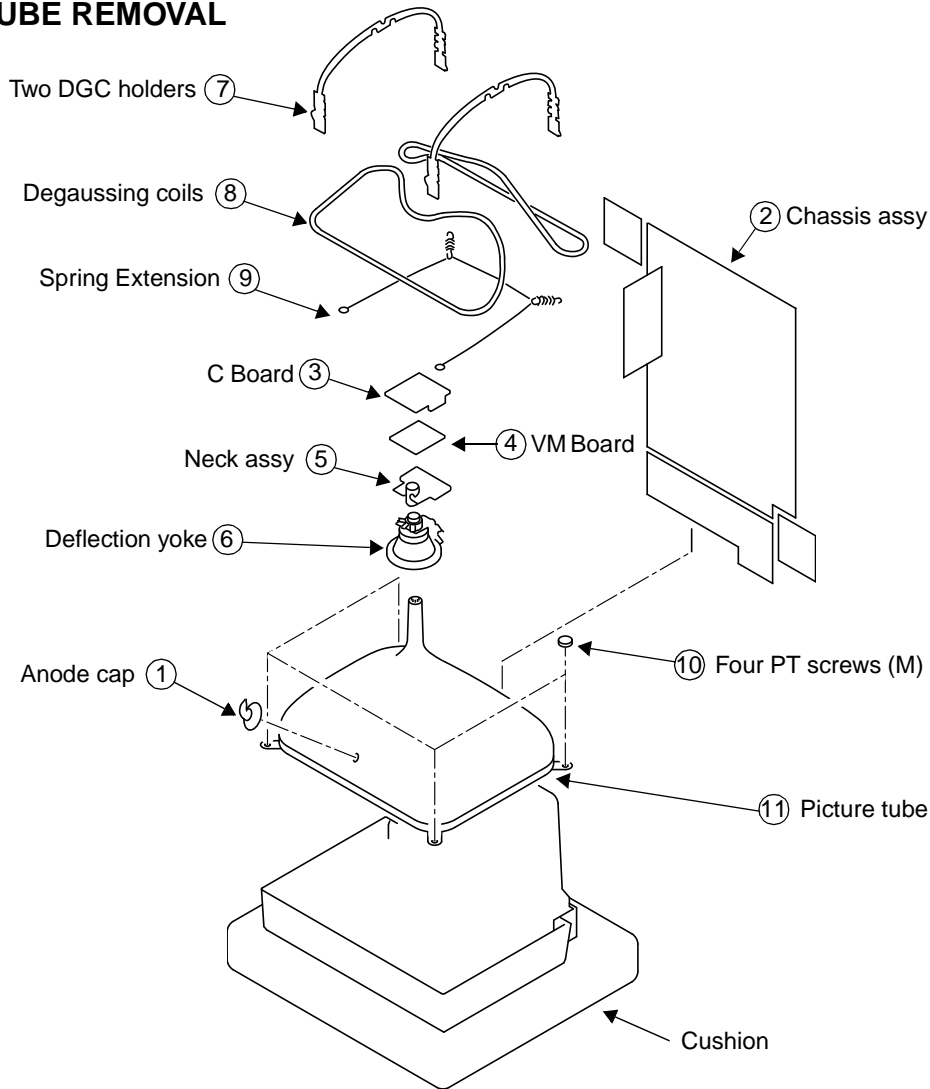

### • REMOVAL OF ANODE-CAP

**Note :** Short circuit the anode of the picture tube and the anode cap to the metal chassis, CRT shield or carbon paint on the CRT, after removing the anode.

#### \* REMOVING PROCEDURES.

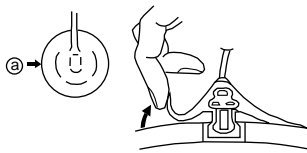

① Turn up one side of the rubber cap in the direction indicated by the arrow (a)

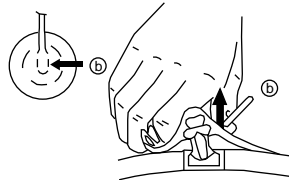

② Using a thumb pull up the rubber cap firmly in the direction indicated by the arrow (b)

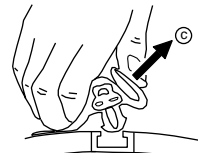

③ When one side of the rubber cap is separated from the anode button, the anode-cap can be removed by turning up the rubber cap and pulling it up in the direction of the arrow (c)

### • HOW TO HANDLE THE ANODE-CAP

- ① To prevent damaging the surface of the anode-cap do not use sharp materials.
- ② Do not apply too great a pressure on the rubber, as this may cause damage to the anode connector.
- ③ A metal fitting called a shatter hook terminal is fitted inside the rubber cap. Do not turn the rubber foot over excessively this may cause damage if the shatter hook sticks out.

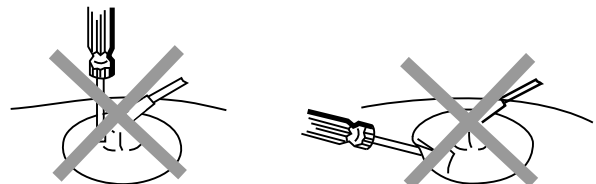

## REMOVAL AND REPLACEMENT OF THE MAIN-BRACKET BOTTOM PLATES.

### (1) REMOVING THE PLATES

In the event of servicing being required to the solder side of the A Board printed wiring board, the bottom plates fitted to the main chassis bracket require to be removed.

This is performed by cutting the gates with a sharp wire cutter at the locations shown and indicated by arrows.

**Note :** There are 2 plates fitted to the main bracket and secured by 4 gates.  
Only remove the necessary plate to gain access to the printed wiring board.

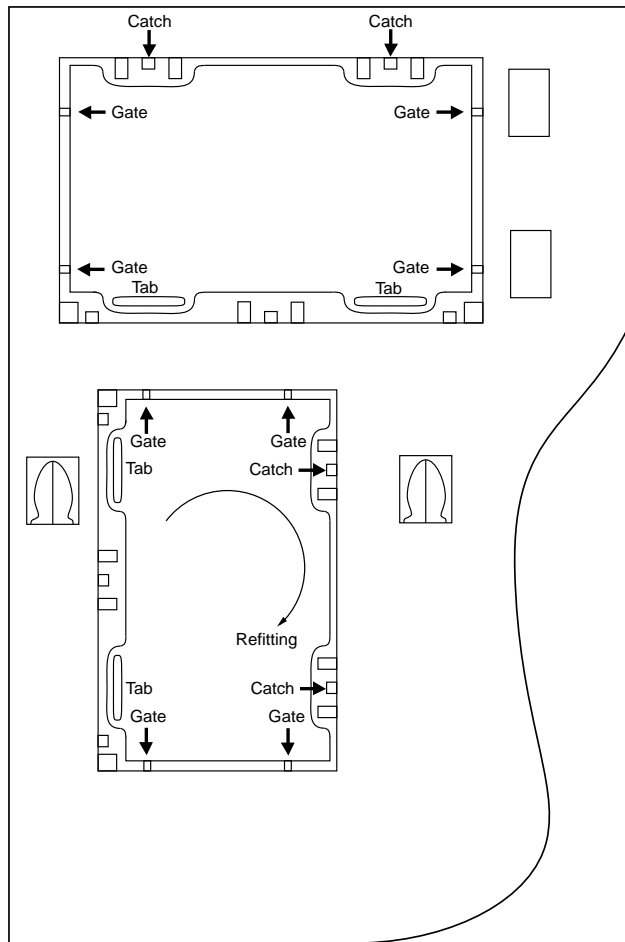

**For safety reasons, on no account should the plates be removed and not refitted after servicing.**

### (2) REFITTING THE PLATES

Because the plates differ in size it is important that the correct plates are refitted in their original location.

Please note that the plates need to be rotated 180 degrees from the cut position to allow the tabs to be fitted in the catch positions.

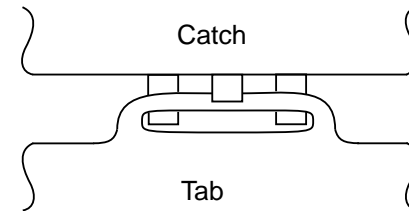

## SECTION 3 SET-UP ADJUSTMENTS

- When complete readjustment is necessary or a new picture tube is installed, carry out the following adjustments.
- Unless there are specific instructions to the contrary, carry out these adjustments with the rated power supply.
- Unless there are specific instructions to the contrary, set the controls and switches to the following settings :

Contrast ..... 80% [or remote control normal]  
 Brightness ..... 50%

Carry out the following adjustments in this order :

- 3-1. Beam Landing
- 3-2. Convergence
- 3-3. Focus
- 3-4. White Balance

- Note :** Test equipment required
1. Color bar/pattern generator.
  2. Degausser.
  3. Oscilloscope.
  4. Digital multimeter.
  5. DC Power supply.

### Preparation:

1. In order to reduce the influence of geomagnetism on the set's picture tube, face it in an easterly or westerly direction.
2. Switch on the set's power and degauss with the degausser.

### 3-1. BEAM LANDING

1. Input an all white signal from the pattern generator. Set the Contrast and Brightness to normal.
2. Set the pattern generator raster signal to Red.
3. Move the deflection yoke forward and adjust with the purity control so that the Red is at the centre and the Blue and Green take up equally sized areas on each side of the screen. [See Fig.3-1 - 3-3].
4. Move the deflection yoke forward and adjust so that the entire screen becomes Red. [See Fig.3-1]
5. Switch the raster signal to Blue, then to Green and verify the condition.
6. When the position of the deflection yoke has been determined, fasten the deflection yoke with the screws.
7. If the beam does not land correctly in all the corners, use a magnet to correct it. [See Fig.3-4]

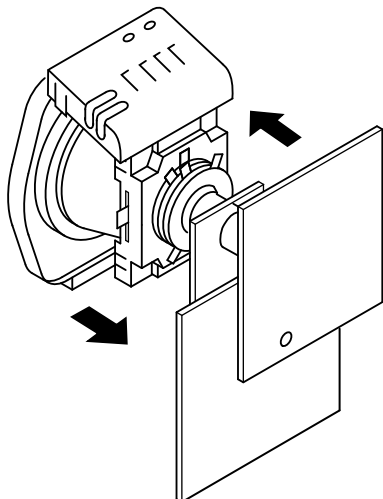

Fig. 3-1

Fig. 3-2

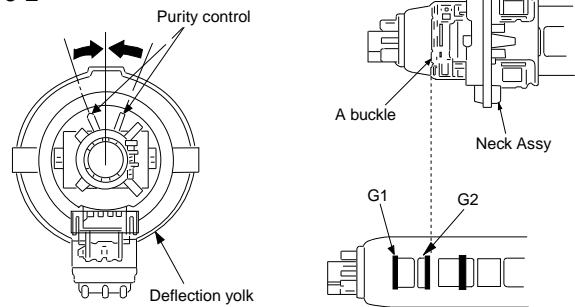

Fig. 3-3

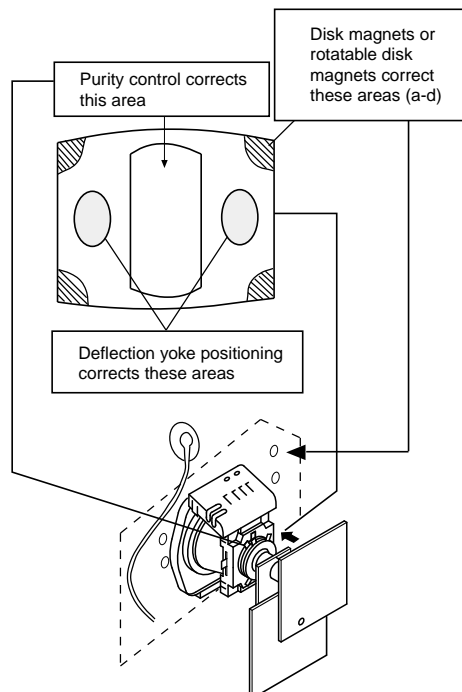
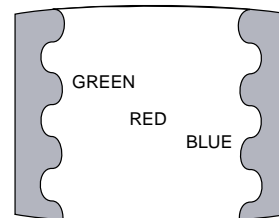

Fig. 3-4



## 3-2. CONVERGENCE

### Preparation:

- Before starting this adjustment, adjust the focus, horizontal size and vertical size.
- Minimize the Brightness setting.
- Input a dot pattern from the pattern generator.

### (1) Horizontal and vertical static convergence

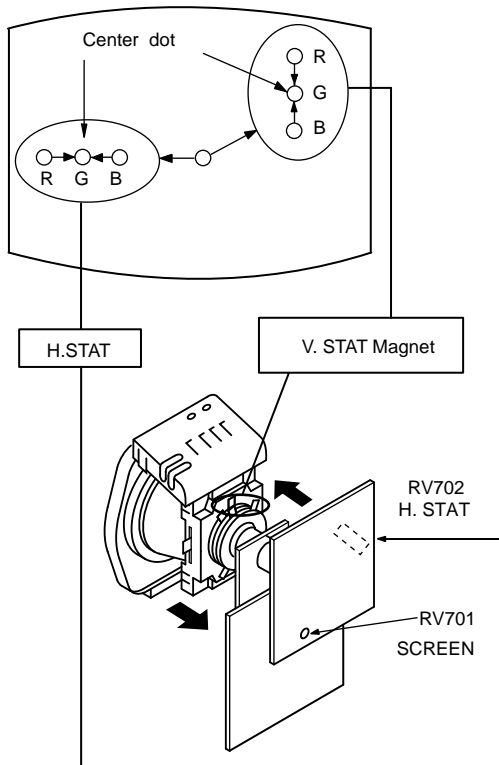

1. [Moving horizontally], adjust the H.STAT control so that the Red, Green and Blue points are on top of each other at the centre of the screen.
2. [Moving vertically], adjust the V.STAT magnet so that the Red, Green and Blue points are on top of each other at the centre of the screen.
3. If the H.STAT variable resistor is unable to bring the Red, Green and Blue points together at the centre of the screen, adjust the horizontal convergence with the H.STAT variable resistor and the V.STAT magnet in the manner indicated below. [In this case, the H.STAT variable resistor and the V.STAT magnet influence each other].

- Tilt the V.STAT magnet and adjust the static convergence by opening or closing the V.STAT magnet.

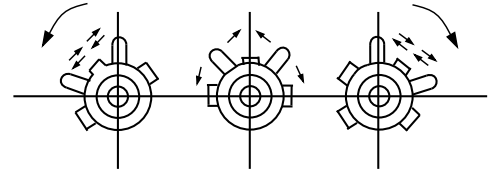

4. If the V.STAT magnet is moved in the direction of the (a) and (b) arrows, the Red, Green and Blue points move as indicated below.

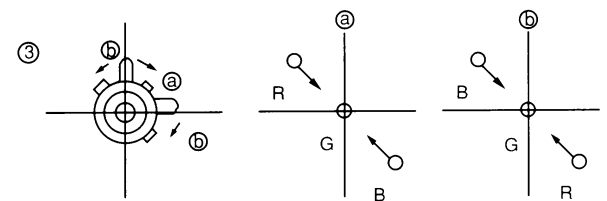
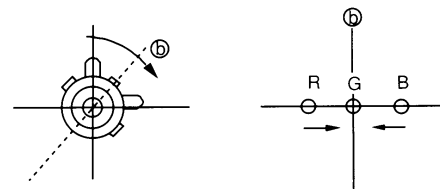
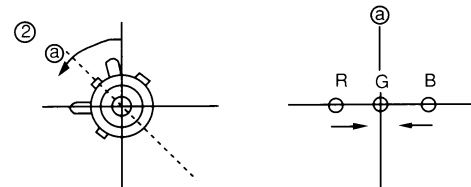
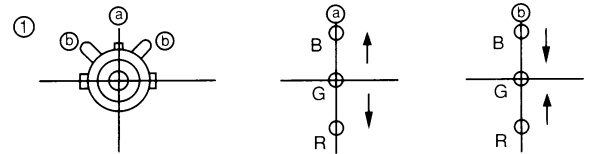

• **Operation of the BMC (Hexapole) magnet.**

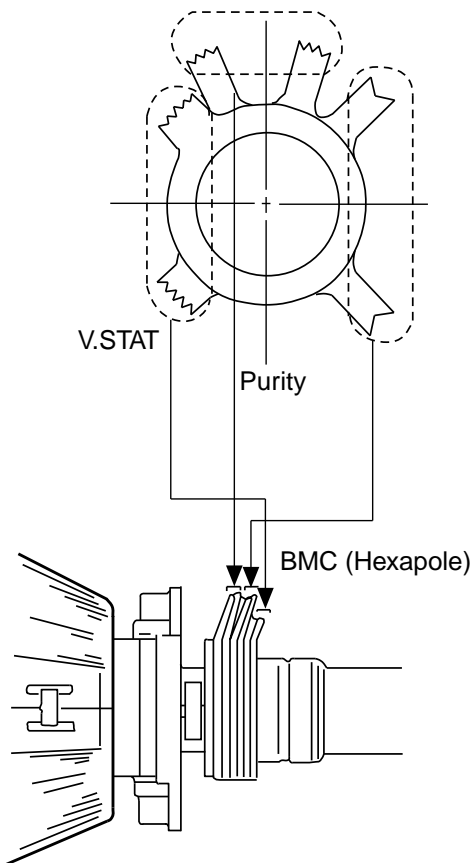
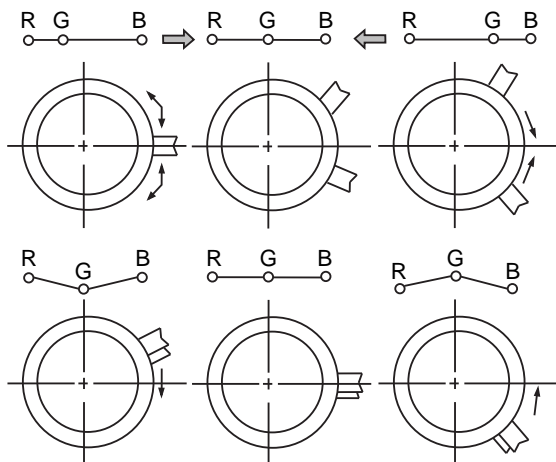

- The respective dot position resulting from moving each magnet interact, so be sure to perform adjustment whilst tracking.  
Use the H.STAT VR to adjust the Red, Green and Blue dots so that they coincide at the centre of the screen (by moving the dots in the horizontal direction).

**(2) Dynamic convergence adjustment.**

**Preparation:**

- Before starting this adjustment, adjust the horizontal and vertical static convergence.
1. Remove the deflection yoke spacer.

2. Tilt the deflection yoke as indicated in the figure below and optimize the convergence.
3. Re-install the deflection yoke spacer.

**Note :** This adjustment will affect the geometry of the display, therefore adjust to obtain the optimum setting.

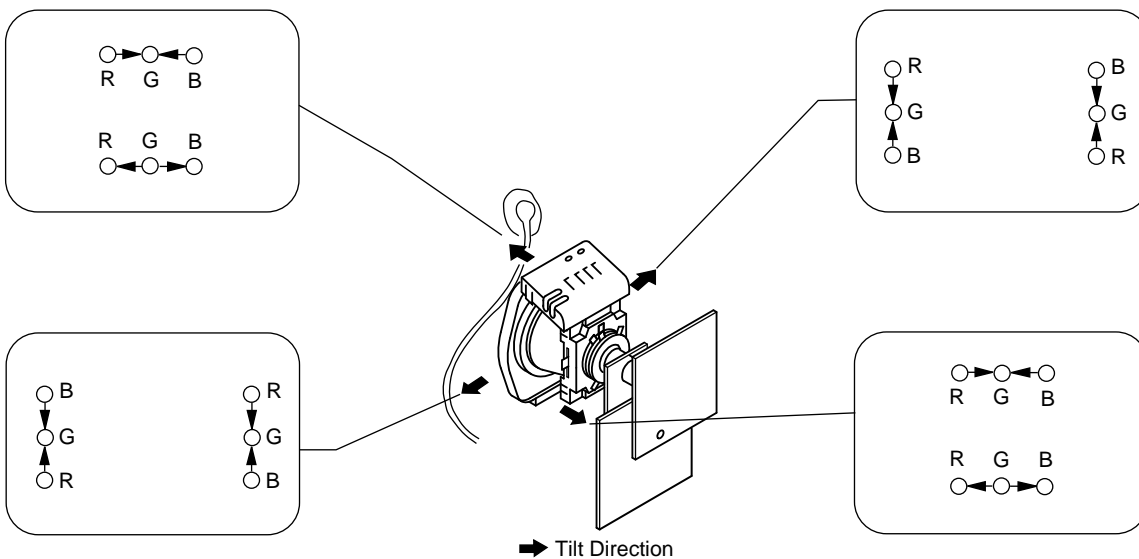

**(3) Screen corner convergence.**

- If you are unable to adjust the corner convergence properly, correct them with the use of permalloy assemblies.

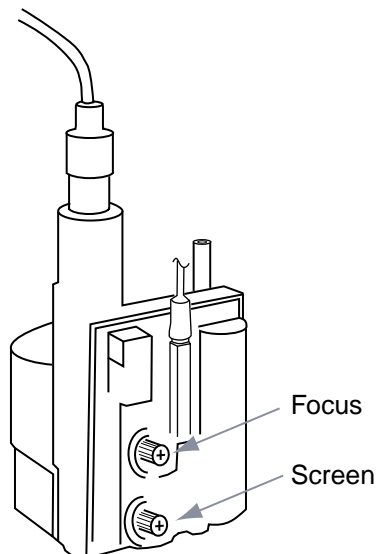
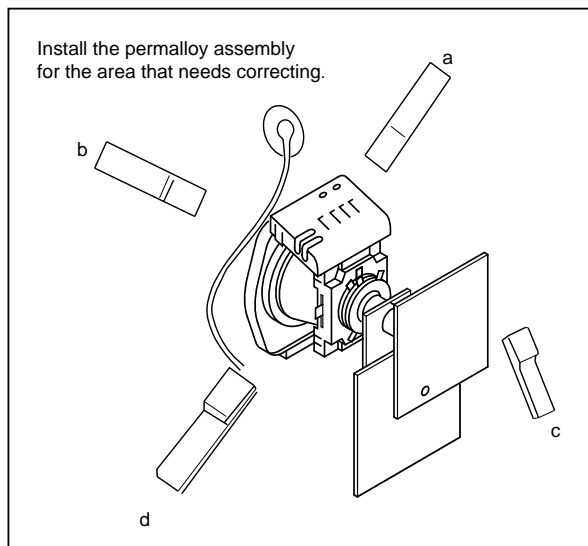
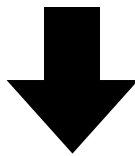
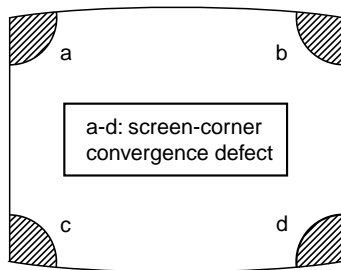

**3-3. FOCUS**

1. Receive a television broadcast signal.
2. Normalise the picture setting.
3. Adjust the focus control on the flyback transformer for the best focus at the centre of the screen.  
Bring only the centre area of the screen into focus, the magenta ring appears on the screen. In this case, adjust the focus to optimize the screen uniformly.

**3-4. WHITE BALANCE**

**G2 Screen Adjustment**

1. Switch the TV set into AV mode [apply a cross-hatch signal].
2. Enter into the 'Service mode' and select 'Picture Control'.
3. Enter 'Picture Control' and select 'Personal' press OK.
4. Return to 'Picture Control' menu and select 'Reset'.
5. Measure the voltages on the 3 cathodes of the CRT, Kr,Kg and Kb using an oscilloscope with a 100:1 probe.
6. Connect the oscilloscope to the CRT cathode which recorded the highest voltage and adjust [RV702 SCREEN] located on the C Board to obtain a reading of 175V.

**White Balance Adjustment**

1. Input an all white signal from the pattern generator.
2. Enter into the Service Mode.
3. Enter into the 'Picture Adjustment' service menu.
4. Select 'Sub contrast' and adjust to 7.
5. Select the 'Green drive' and adjust so that the white balance becomes optimum.
6. Select the 'Blue drive' and adjust so that the white balance becomes optimum.
7. Press the 'TV' button on the remote commander to return to TV operation.

PICTURE ADJUSTMENT	
AFC mode	1
REF position	2
SCP BGR	1
SCP BGF	1
Trap fo	0
Sub contrast	Adj
Sub colour	Adj
Sub brightness	Adj
Sub hue	Adj
Green drive	Adj
Blue drive	Adj
Green cutoff	Adj
Blue cutoff	Adj
Gamma	0
Pre / overshoot	0
Y delay	3

# SECTION 4 CIRCUIT ADJUSTMENTS

## 4-1. ELECTRICAL ADJUSTMENTS

Service adjustments to this model can be performed using the supplied Remote Commander RM-887.

### HOW TO ENTER INTO SERVICE MODE

1. Turn on the main power switch and enter into the stand-by mode.
2. Press the following sequence of buttons on the Remote Commander.

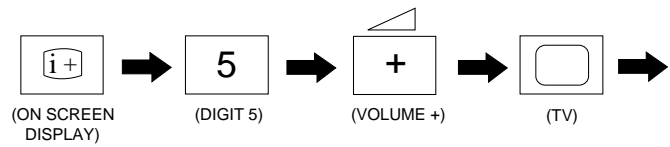

- 'TT--' will appear in the upper right corner of the screen. Other status information will also be displayed.
3. Press 'MENU' on the remote commander to obtain the following menu on the screen.

TEST MENU
> Picture
Geometry
Sound
TV Status
AGC Adjust
Technical

4. Move to the corresponding adjustment item using the 'Green' [up] or 'Blue' [down] buttons on the Remote Commander.
5. Press the 'Yellow' button to enter into the required menu item.
6. Press the 'Menu' button on the Remote Commander to quit the Service Mode when all adjustments have been completed.

**Note :**The data shown in the 'TV STATUS' table is dependant on destination and country.

PICTURE	
R - Drive	Adj
G - Drive	Adj
B - Drive	Adj
R - cut - off	Adj
G - cut - off	Adj
B - cut - off	Adj
ID - start	02
ID - stop	01
ID - level	01
Bell-f0	Adj
Sub Colour	Adj
Sub Brightness	Adj

GEOMETRY	
V centre	Adj
V size	Adj
V Lin	Adj
S Corr	Adj
H Cent	Adj
H Size	Adj
Pin Amp	Adj
Upper Pin	Adj
Lower Pin	Adj
Upper V lin	Adj
Lower V lin	Adj
Pin Phase	Adj
V Bow	Adj
V Angle	Adj
Upper V Lin	Adj
Lower V Lin	Adj
Left HBLK	07
Right HBLK	07
CD Mode (AV)	01
EHT-comp	12

SOUND	
Nicam Error Lower	20
Nicam Error Upper	80
Nicam Error Rate	xx [Status only]
AGC Gain Level	xx [Status only]

TV STATUS	
Destination	A/L/E/U/D/B/K/R
Text Language	East/West

TECHNICAL	
GD - Secam	31
BD - Secam	31
RC - Secam	15
GC - Secam	15
BC - Secam	14
GD - Sports	32
BD - Sports	34
RC - Sports	14
GC - Sports	15
BC - Sports	16
Y - Delay (AV)	07

### SUB BRIGHTNESS ADJUSTMENT

1. Input a Phillips colour pattern.
2. Press 'TEST' 'TEST' 13 on the Remote Commander.
3. Adjust the 'Sub-Brightness' data so that there is barely a difference between the 0 IRE and 10 IRE signal levels.

### SUB CONTRAST ADJUSTMENT

1. Input a video signal that contains a small 100% white area on a black background
2. Set the picture control to maximum. ['TT01']
3. Connect an oscilloscope to Pin 1 of CN504 [A Board].

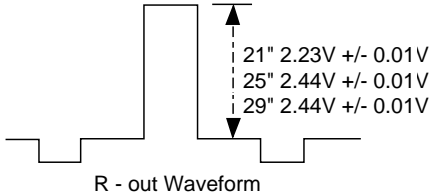

4. Enter into the 'Picture' service menu.
5. Adjust the 'R - Drive' data to obtain the following waveform.

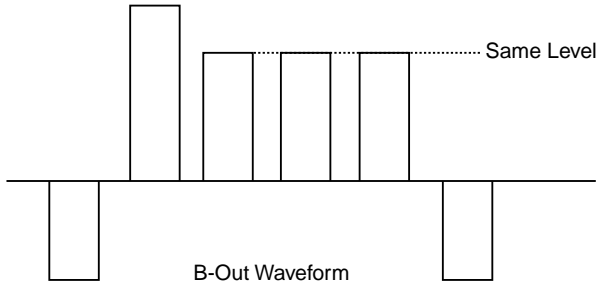

### SUB COLOUR ADJUSTMENT

1. Receive a PAL colour bar signal.
2. Connect an oscilloscope to Pin 3 of CN504 [A Board].
3. Enter into the 'Picture' service menu.
4. Adjust the 'Sub Colour' data so that the Cyan, Magenta and Blue colour bars are of equal levels as indicated below.

**Note:** Ensure that no signal is applied to the Antenna socket while carrying out the following IF adjustments.

### SYSTEM B/G, D/K, I & L I.F ADJUSTMENT

1. Input a 38.9Mhz carrier signal at 100dBuV to Pin 11 [IF output] of the tuner [TU101].
2. Measure the voltage at Pin 17 of [IC101].
3. Adjust L103 [A Board] to obtain a voltage of 1.4V +/- 0.3V.

### SYSTEM L BAND 1 I.F ADJUSTMENT

1. Input a 33.9MHz carrier signal at 100dBuV to Pin 11 [IF output] of the tuner [TU101].
2. Select 'system L' + C00 [channel 00].
3. Measure the voltage at Pin 17 [IC101].
4. Adjust RV101 [A Board] to obtain a voltage of 1.4V +/- 0.3V.

### TUNER AGC ADJUSTMENT

1. Receive a signal of 62dBuV / 75 ohm terminated, via the tuner antenna socket.
2. Connect a voltmeter to JW130 [A Board].
3. Enter into the 'Test Menu'.
4. Select the 'AGC Adjust' menu item.
5. Adjust the data using the Yellow and Green buttons on the Remote Commander to obtain a voltage of 3.5V +/- 0.3V.

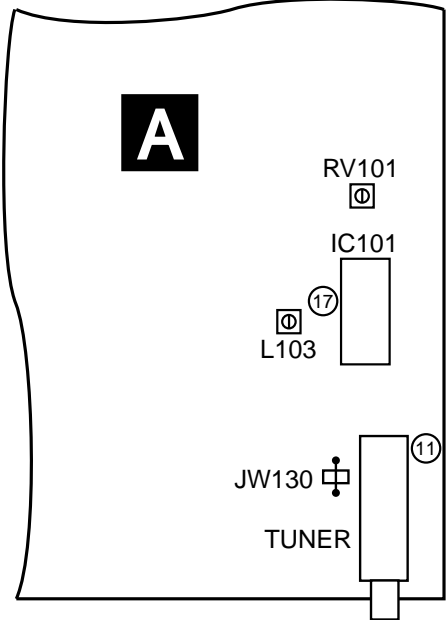

A Board component side

## BELL FILTER ADJUSTMENT (Secam models only)

**Note :** Ensure that the TV set has been powered up for at least 1 minute to allow for drift before carrying out the following adjustment.

1. Input a video SECAM Colour Bar signal via AV1.
2. Connect an oscilloscope to pin 1 of CN504 [R-OUT] on the A board.
3. Enter into the 'Picture' menu and select 'Bell-f0'.
4. Decrease the register of 'Bell-f0' until the following waveform change between RED and BLUE is obtained.

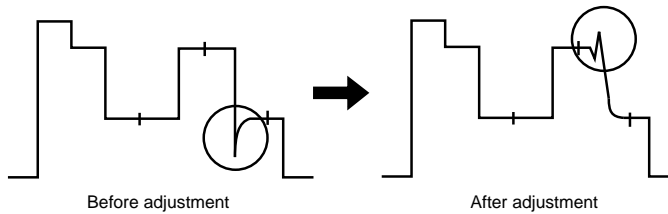

5. When the correct waveform has been obtained add an additional 7 steps to the register.

## DEFLECTION SYSTEM ADJUSTMENT

1. Enter into the 'Geometry' service menu.
2. Select and adjust each item in order to obtain the optimum image.

GEOMETRY	
V centre	Adj
V size	Adj
V Lin	Adj
S Corr	Adj
H Cent	Adj
H Size	Adj
Pin Amp	Adj
Upper Pin	Adj
Lower Pin	Adj
Upper V lin	Adj
Lower V lin	Adj
Pin Phase	Adj
V Bow	Adj
V Angle	Adj
Upper V Lin	Adj
Lower V Lin	Adj
Left HBLK	07
Right HBLK	07
CD Mode (AV)	01
EHT-comp	12

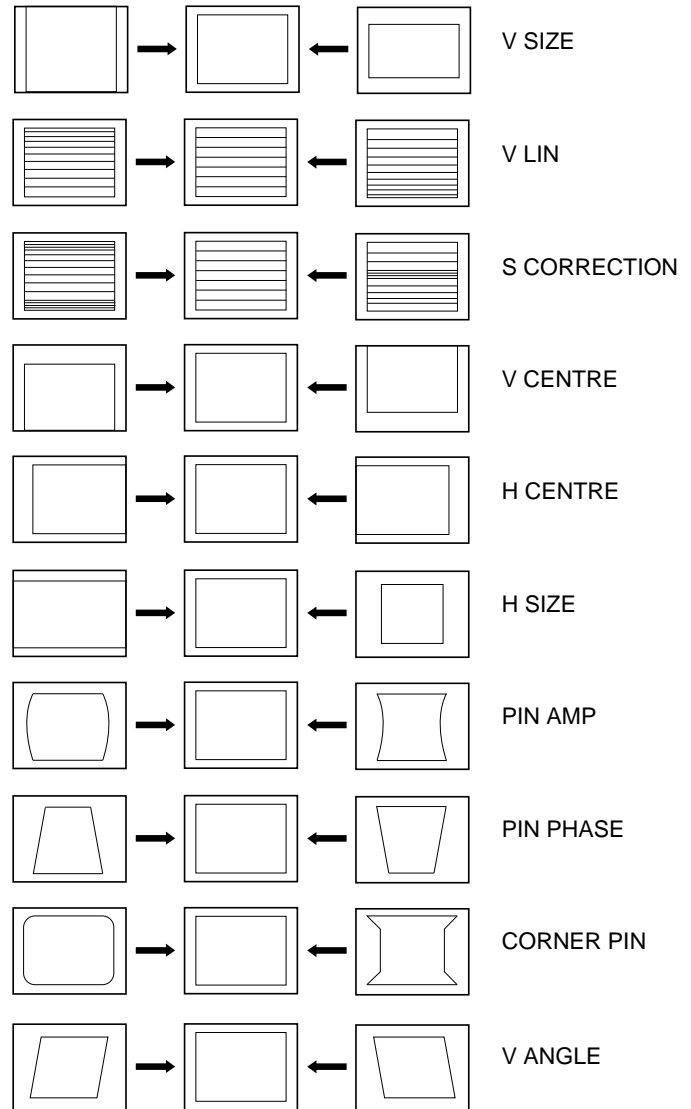

## 4-2. TEST MODE 2:

Is available by pressing 'TEST' button twice, OSD 'TT' appears. The functions described below are available by pressing the two numbers. To release the Test mode 2, press 0 twice, or switch the TV into stand-by mode, or press the  TV button on the remote commander.

00	Cancel Test mode
01	Picture maximum
02	Picture minimum
03	Volume 35%
04	Volume 50%
05	Volume 65%
06	Volume 80%
07	Ageing mode On/Off
08	Set shipping conditions
09	Display TV Status
10	No function
11	Sub Picture Adjustment
12	Sub Colour Adjustment
13	Sub Brightness Adjustment
14	Text H position Adjustment
15	Rotation test
16	Picture level 50%
17	Audio mute ON
18	Disable Blanking
19	No function
20	No function
21	Destination A
22	Destination L
23	Destination E
24	Destination U
25	Destination D
26	Destination B
27	Destination K
28	Destination R
29	No function
30	No function
31	Auto shutoff Disable/Enable
32	RGB priority Disable/Enable
33	Rotation On/OFF
34	Text language East/West
35	Wide CRT/4:3 CRT
36	VM ON/OFF test
37	No function
38	No function
39	No function
40	No function
41	Re-initialize the NVM [Only when Prog=59]

42	Re-initialise geometry settings [Only when Prog=59]
43	No function
44	No function
45	No function
46	No function
47	No function
48	Set NVM as NON Virgin [Only when Prog=59]
49	Set NVM as Virgin [Only when Prog=59]
50	No function
51	No function
52	No function
53	No function
54	No function
55	No function
56	No function
57	No function
58	No function
59	No function
60	No function
61	Auto AGC Adjust
62	Alternative Dest B Autotuning
63	Enable/Disable Y/C input
64	Signal Quality Check for Auto Tune
65	Signal Quality NOT Checked for Auto Tune
66	No function
67	Manual AGC Adjust
68 -100	No function

5-1 BLOCK DIAGRAMS (1)

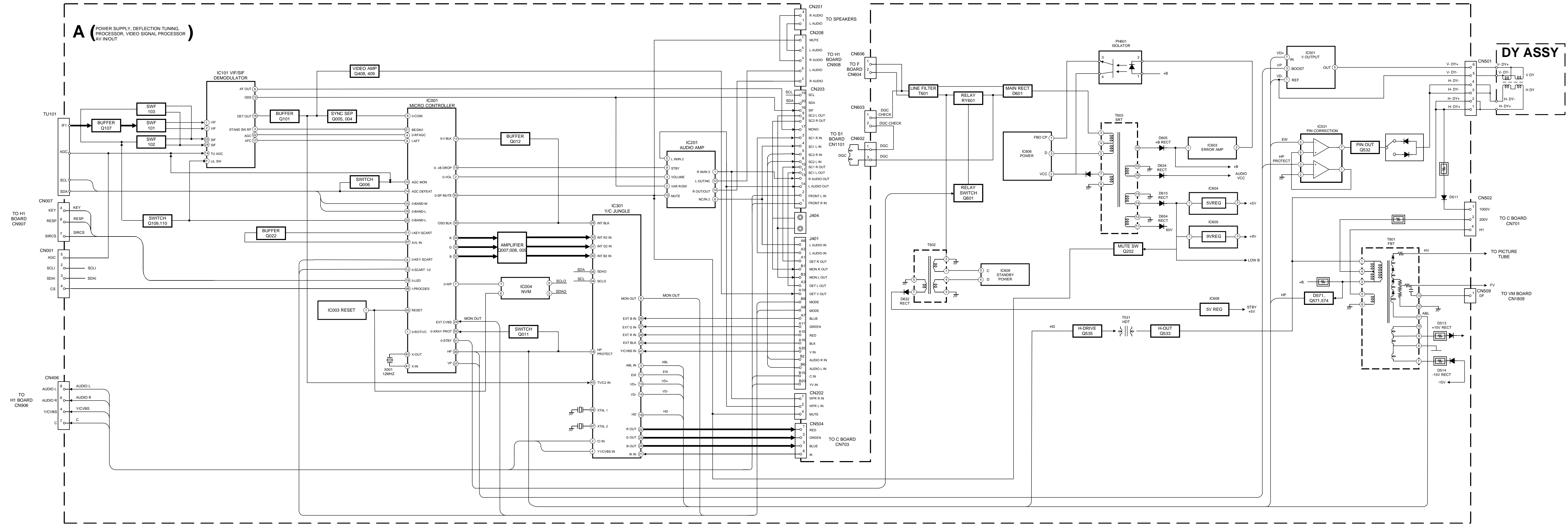



## 5-1 BLOCK DIAGRAMS (2)

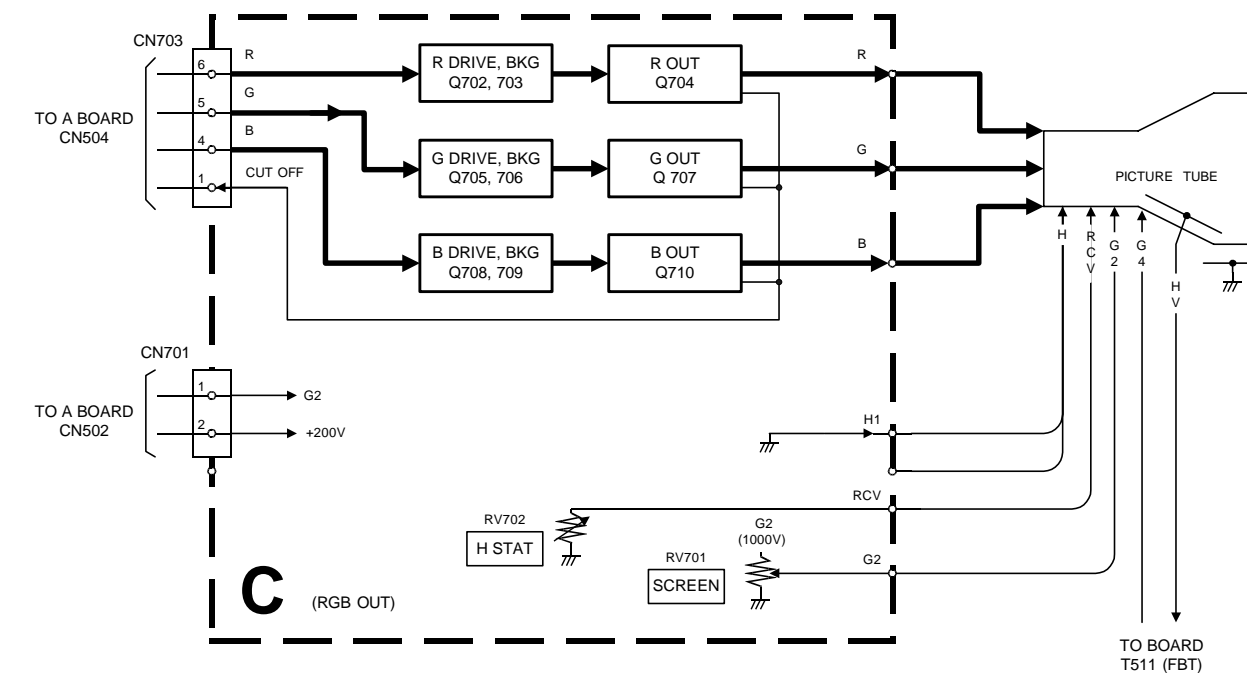
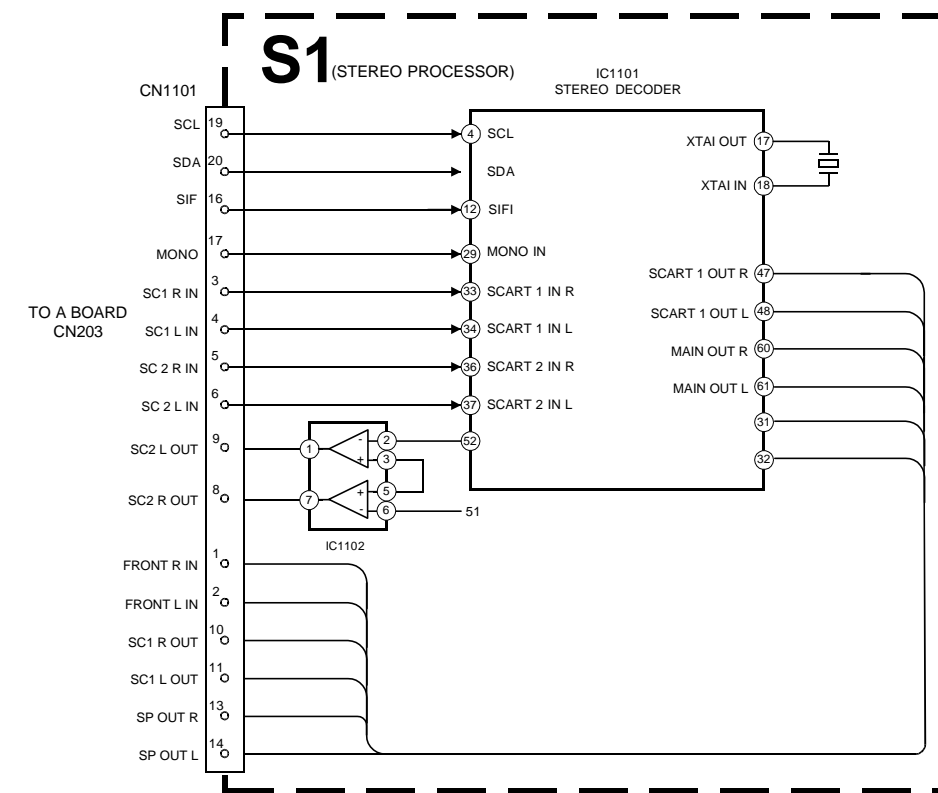
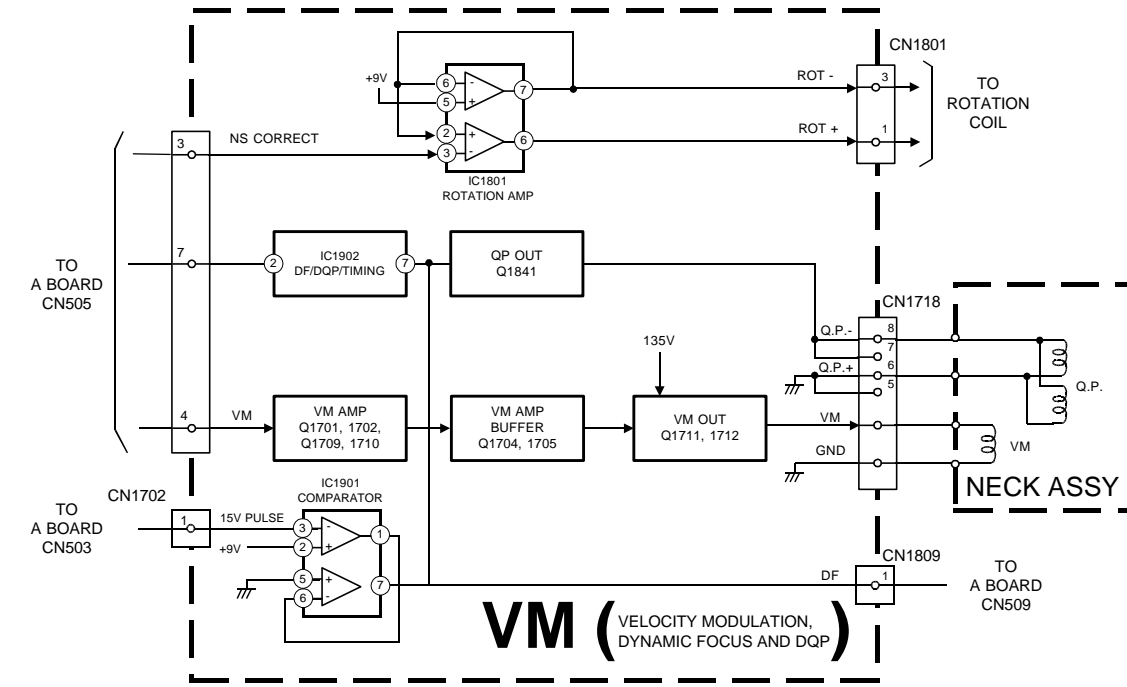
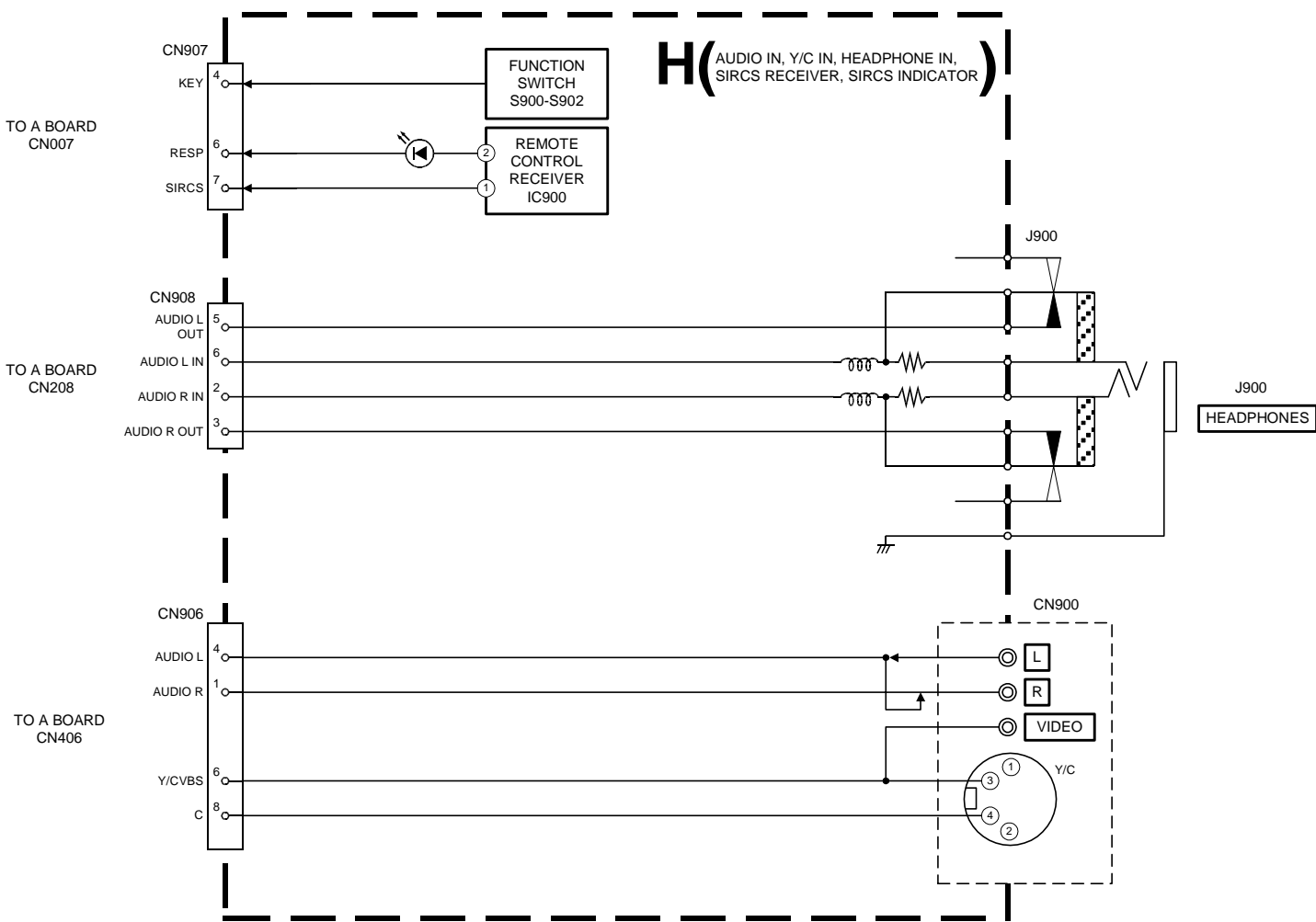
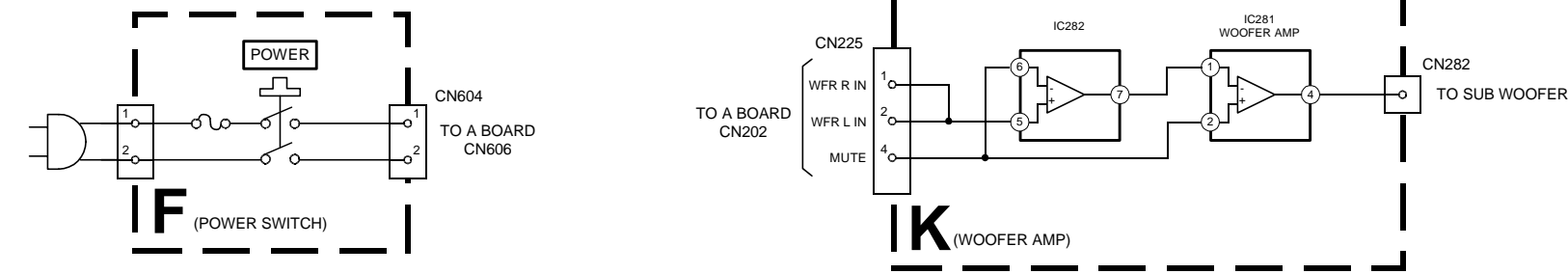

## 5-2. CIRCUIT BOARD LOCATION

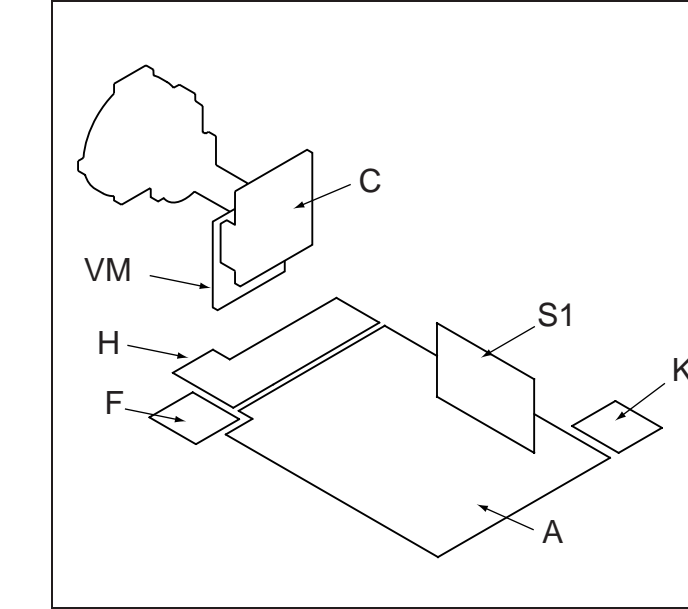

## 5-3. SCHEMATIC DIAGRAMS AND PRINTED WIRING BOARDS

- Note :**
- All capacitors are in  $\mu\text{F}$  unless otherwise noted.
  - $\text{pF}$  :  $\mu\text{F}$  50WV or less are not indicated except for electrolytic types.
  - Indication of resistance, which does not have one for rating electrical power, is as follows.

Pitch : 5mm  
Electrical power rating : 1/4W

- Chip resistors are 1/10W
- All resistors are in ohms.  
k = 1000 ohms, M = 1000,000 ohms
- : nonflammable resistor.
- : fusible resistor.
- : internal component.
- : panel designation or adjustment for repair.

- All variable and adjustable resistors have characteristic curve B, unless otherwise noted.
- All voltages are in Volts.
- Readings are taken with a 10Mohm digital multimeter.
- Readings are taken with a color bar input signal.
- Voltage variations may be noted due to normal production tolerances.

- : B + bus.
- : B - bus.
- : RF signal path.
- : earth - ground.
- : earth - chassis.

## Reference Information

RESISTOR	RN	: METAL FILM
	RC	: SOLID
	FPRD	: NON FLAMMABLE CARBON
	FUSE	: NON FLAMMABLE FUSIBLE
	RS	: NON FLAMMABLE METAL OXIDE
	RB	: NON FLAMMABLE CEMENT
	RW	: NON FLAMMABLE WIREWOUND
		: ADJUSTMENT RESISTOR
COIL	LF-8L	: MICRO INDUCTOR
CAPACITOR	TA	: TANTALUM
	PS	: STYROL
	PP	: POLYPROPYLENE
	PT	: MYLAR
	MPS	: METALIZED POLYESTER
	MPP	: METALIZED POLYPROPYLENE
	ALB	: BIPOLAR
	ALT	: HIGH TEMPERATURE
	ALR	: HIGH RIPPLE

**Note :** The components identified by shading and marked are critical for safety. Replace only with the part numbers specified in the parts list.

**Note :** Les composants identifiés par une trame et par une marque sont d'une importance critique pour la sécurité. Ne les remplacer que par des pièces de numéro spécifié.

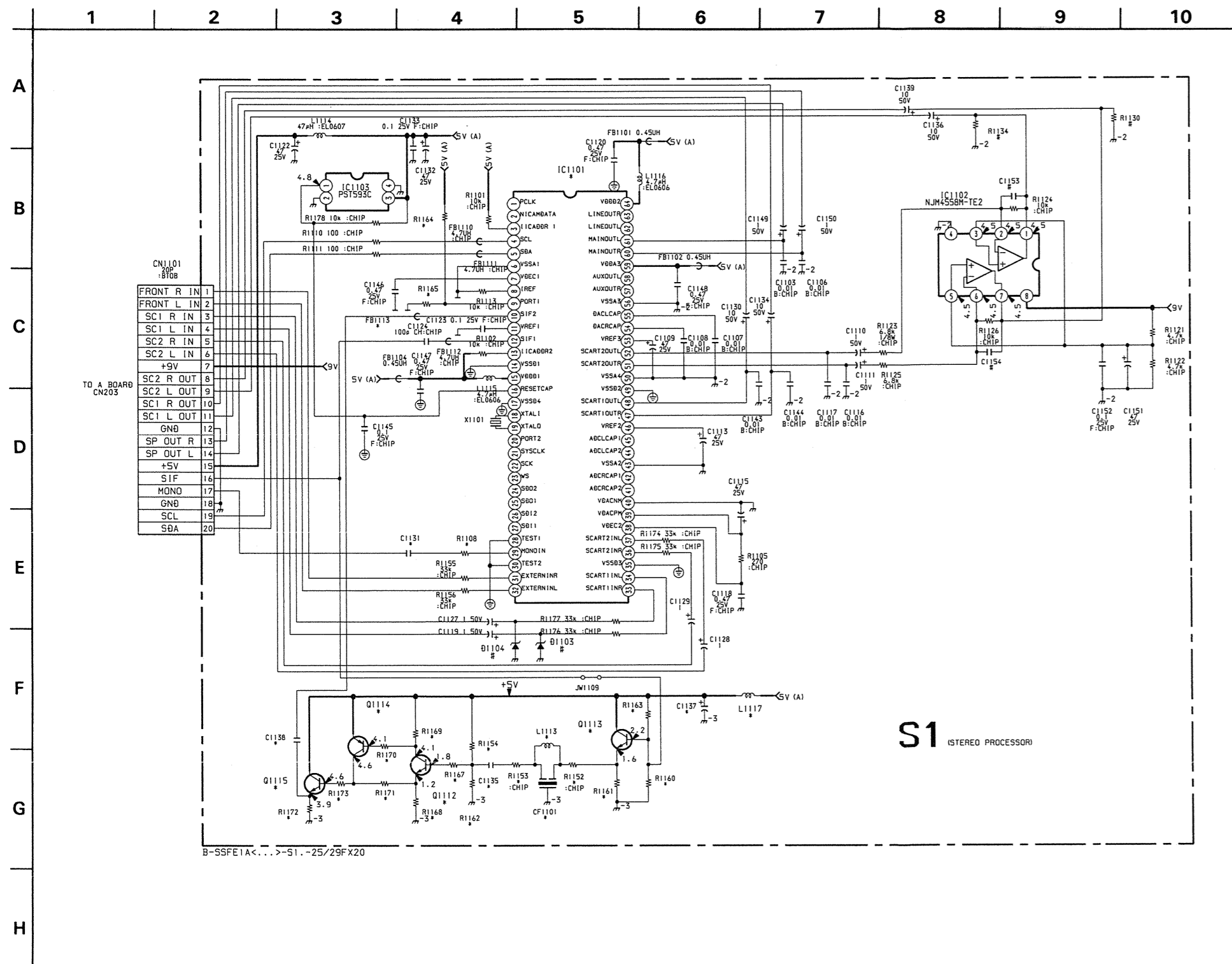

S1 BOARD \*MARK

Ref	25FX20A	25FX20B	25FX20D	25FX20E	25FX20K	25FX20R	29FX20U
C1131	-	0.047MF	-	-	-	-	-
C1135	-	100PF	-	-	-	-	-
C1137	-	47MF	-	-	-	-	-
C1138	-	100PF	-	-	-	-	-
CF1101	-	6.5MHZ	-	-	-	-	-
FB1113	-	4.7UH	-	-	-	-	-
IC1101	TDA9870A	TDA9875A	TDA9870A	TDA9875A	TDA9875A	TDA9870A	TDA9875A
L1113	-	5.6UH	-	-	-	-	-
L1117	-	47UH	-	-	-	-	-
Q1112	-	2SC2412K-T-146-R	-	-	-	-	-
Q1113	-	2SC2412K-T-146-R	-	-	-	-	-
Q1114	-	2SA1037K-T-146-R	-	-	-	-	-
Q1115	-	2SC2412K-T-146-R	-	-	-	-	-
R1108	-	15K	-	-	-	-	-
R1152	-	270	-	-	-	-	-
R1153	-	100	-	-	-	-	-
R1154	-	5.6K	-	-	-	-	-
R1160	-	22K	-	-	-	-	-
R1161	-	470	-	-	-	-	-
R1162	-	3.3K	-	-	-	-	-
R1163	-	22K	-	-	-	-	-
R1164	-	10K	-	10K	10K	-	10K
R1165	SHORT 0	-	SHORT 0	-	-	SHORT 0	-
R1167	-	100	-	-	-	-	-
R1168	-	220	-	-	-	-	-
R1169	-	1K	-	-	-	-	-
R1170	-	10	-	-	-	-	-
R1171	-	680	-	-	-	-	-
R1172	-	470	-	-	-	-	-
R1173	-	1K	-	-	-	-	-

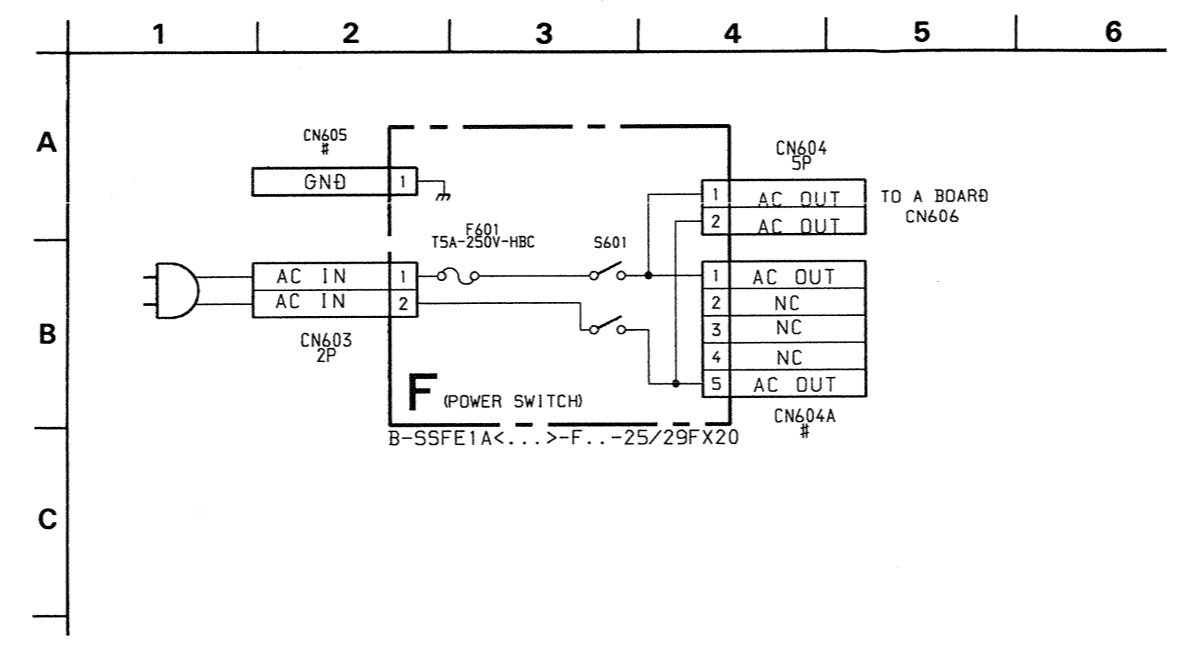

S1 [STEREO PROCESSOR]

S1 Board

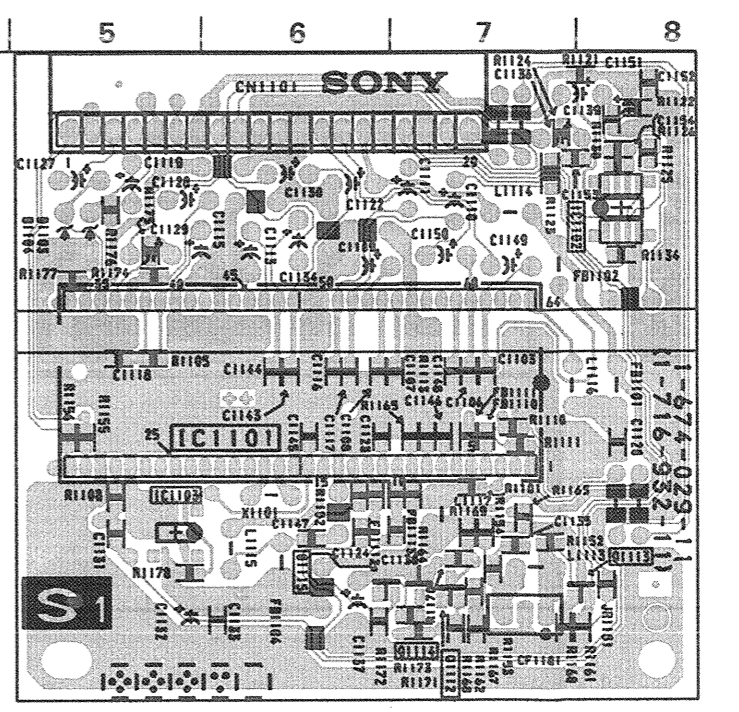
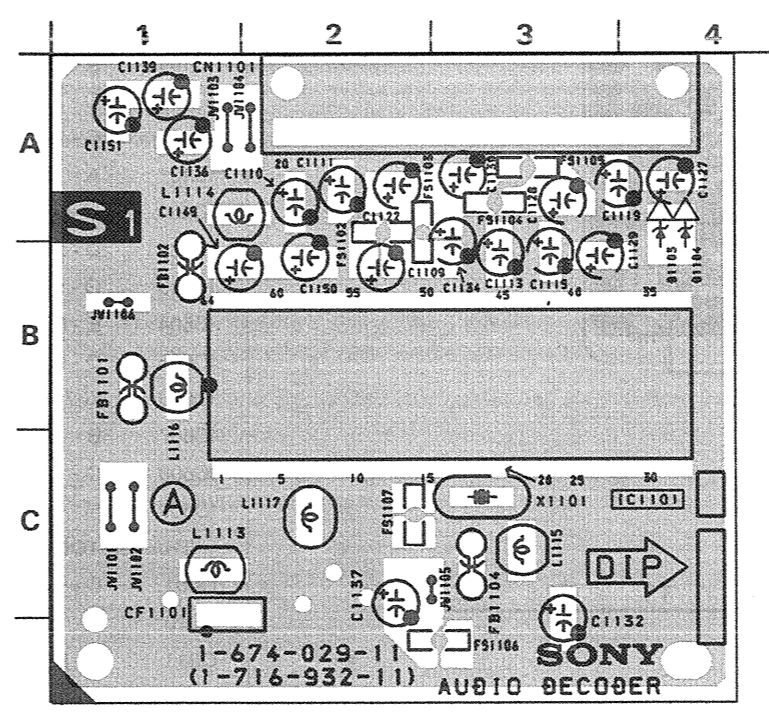

F [POWER SWITCH]

F Board

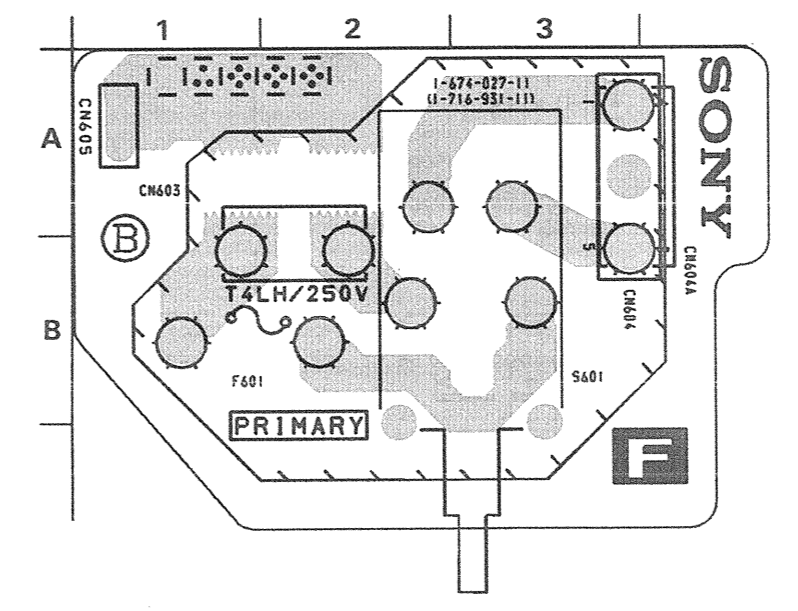

K [WOOFER AMP]

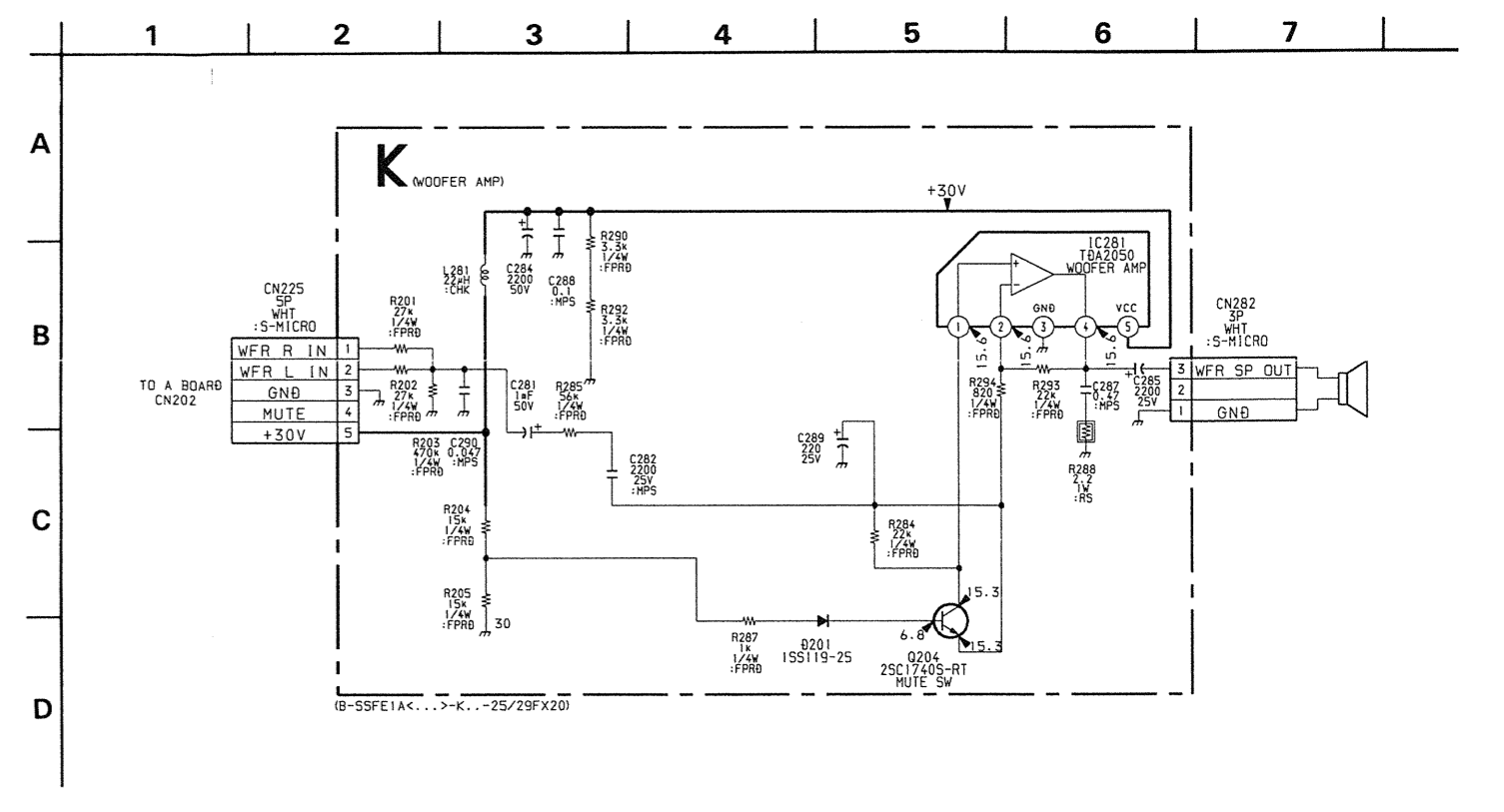

**H** AUDIO IN, Y/C IN, HEADPHONE JACK, SIRCS RECEIVER, SIRCS INDICATOR

H Board

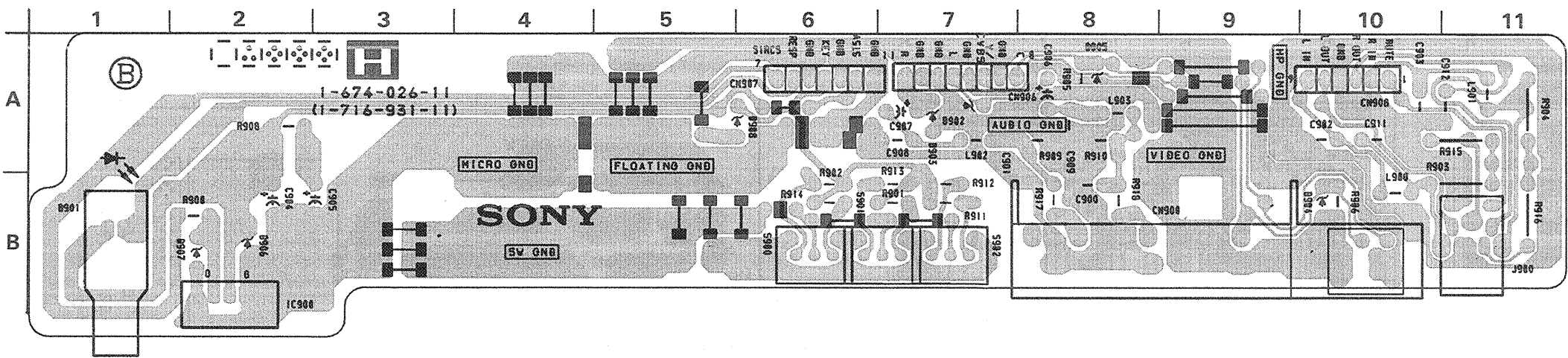

1 2 3 4 5 6 7 8 9 10 11 12

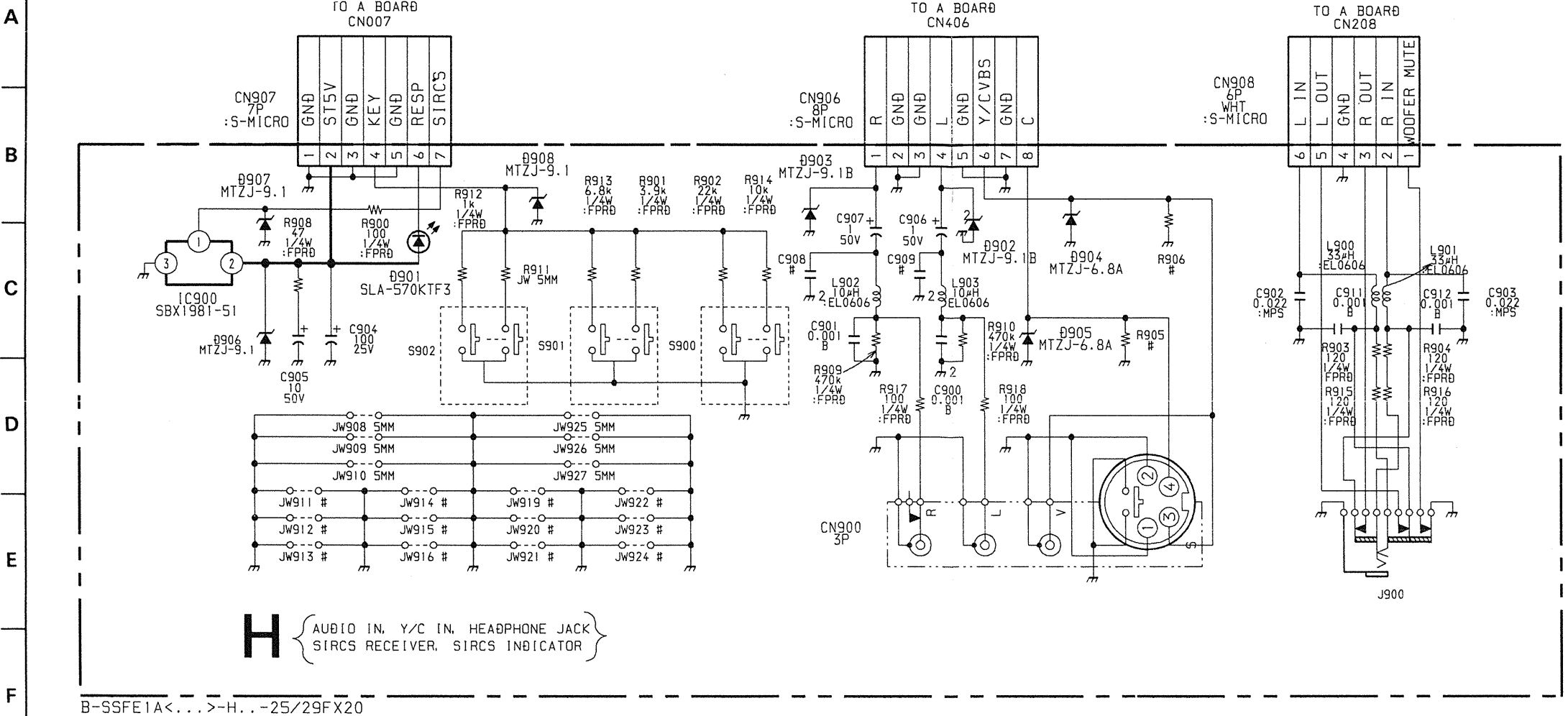

**H** AUDIO IN, Y/C IN, HEADPHONE JACK, SIRCS RECEIVER, SIRCS INDICATOR

B-SSFE1A...-H...-25/29FX20

**A BOARD**

IC	Q532	E - 2	D419	C - 2	
IC001	Q533	F - 1	D420	C - 2	
IC003	Q535	D - 1	D421	D - 2	
IC004	Q571	F - 5	D422	C - 1	
IC101	Q574	B - 8	D423	C - 1	
IC201	Q575	E - 6	D424	B - 12	
IC301	Q576	C - 6	D427	B - 2	
IC401	Q601	D - 10	D430	B - 3	
IC501			D501	I - 4	
IC531			D502	H - 4	
IC603			D511	G - 3	
IC604			D512	H - 3	
IC605			D513	I - 3	
IC606			D514	H - 3	
IC607			D534	D - 3	
IC608			D535	F - 4	
IC609			D536	F - 2	
			D538	F - 4	
			D539	F - 2	
			D541	D - 5	
			D571	F - 5	
			D601	F - 9	
			D602	I - 6	
			D603	H - 6	
			D605	G - 6	
			D608	H - 8	
			D610	F - 7	
			D613	E - 9	
			D619	I - 8	
			D620	I - 7	
			D621	F - 10	
			D626	F - 10	
			D627	F - 10	
			D631	F - 11	
			D632	E - 10	
			D633	E - 9	
			D634	F - 7	
			D654	F - 6	
DIODE					
D001	B - 8	D511	G - 3		
D002	B - 8	D512	H - 3		
D004	C - 10	D513	I - 3		
D007	C - 11	D514	H - 3		
D008	B - 8	D534	D - 3		
D011	E - 12	D535	F - 4		
D013	C - 9	D536	F - 2		
D015	C - 9	D538	F - 4		
D017	C - 9	D539	F - 2		
D018	B - 8	D541	D - 5		
D019	A - 8	D571	F - 5		
D023	C - 9	D601	F - 9		
D098	A - 9	D602	I - 6		
D099	A - 10	D603	H - 6		
D101	B - 2	D605	G - 6		
D104	A - 3	D608	H - 8		
D201	D - 7	D610	F - 7		
D202	D - 7	D613	E - 9		
D203	D - 7	D619	I - 8		
D204	D - 7	D620	I - 7		
D205	D - 8	D621	F - 10		
D206	D - 7	D626	F - 10		
D306	C - 6	D627	F - 10		
D320	B - 8	D631	F - 11		
D402	D - 2	D632	E - 10		
D403	D - 2	D633	E - 9		
D404	D - 2	D634	F - 7		
D405	C - 1				
D406	C - 2				
D407	D - 2				
D408	B - 2				
D409	C - 2				
D410	D - 2				
D411	C - 2				
D414	C - 1				
D416	D - 2				
D418	C - 1				
TRANSISTOR					
Q001	C - 9	D017	C - 9	D539	F - 2
Q010	C - 10	D018	B - 8	D541	D - 5
Q011	B - 8	D019	A - 8	D571	F - 5
Q012	B - 11	D023	C - 9	D601	F - 9
Q013	A - 9	D098	A - 9	D602	I - 6
Q016	B - 8	D099	A - 10	D603	H - 6
Q017	A - 9	D101	B - 2	D605	G - 6
Q018	A - 9	D104	A - 3	D608	H - 8
Q019	A - 9	D201	D - 7	D610	F - 7
Q020	A - 8	D202	D - 7	D613	E - 9
Q021	D - 12	D203	D - 7	D619	I - 8
Q022	D - 11	D204	D - 7	D620	I - 7
Q101	B - 5	D205	D - 8	D621	F - 10
Q102	A - 5	D206	D - 7	D626	F - 10
Q104	A - 6	D306	C - 6	D627	F - 10
Q107	A - 3	D320	B - 8	D631	F - 11
Q108	B - 6	D320	B - 8	D632	E - 10
Q109	B - 3	D402	D - 2	D633	E - 9
Q110	B - 3	D403	D - 2	D634	F - 7
Q111	A - 10	D404	D - 2		
Q112	A - 10	D405	C - 1		
Q160	B - 5	D406	C - 2		
Q201	E - 8	D407	D - 2		
Q202	D - 7	D408	B - 2		
Q328	C - 7	D409	C - 2		
Q329	B - 7	D410	D - 2		
Q405	B - 2	D411	C - 2		
Q417	B - 2	D414	C - 1		
Q418	B - 2	D416	D - 2		
Q501	I - 5	D418	C - 1		

**A** POWER SUPPLY, DEFLECTION, TUNING, PROCESSOR VIDEO SIGNAL PROCESSOR, AV IN/OUT

A Board

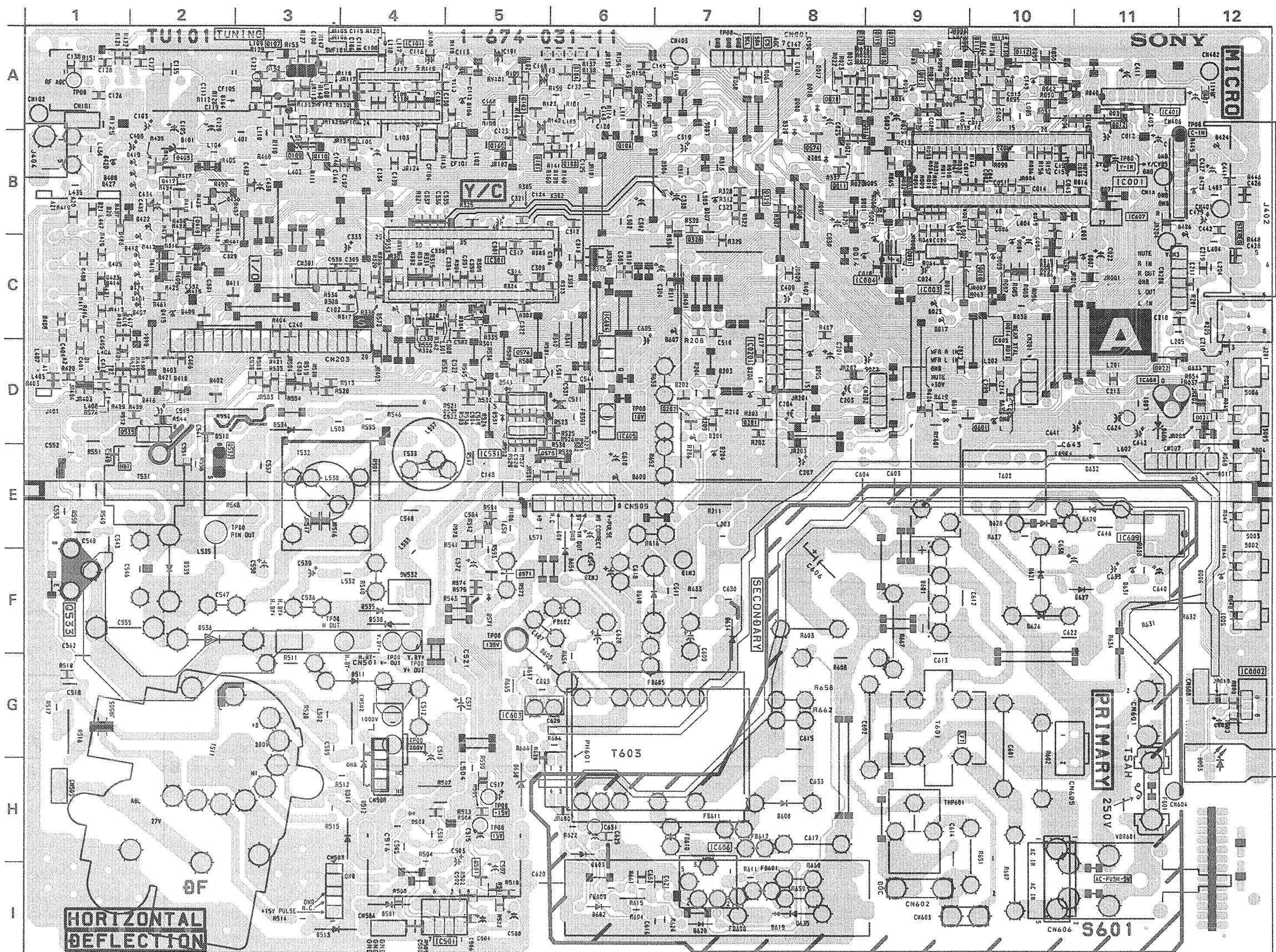



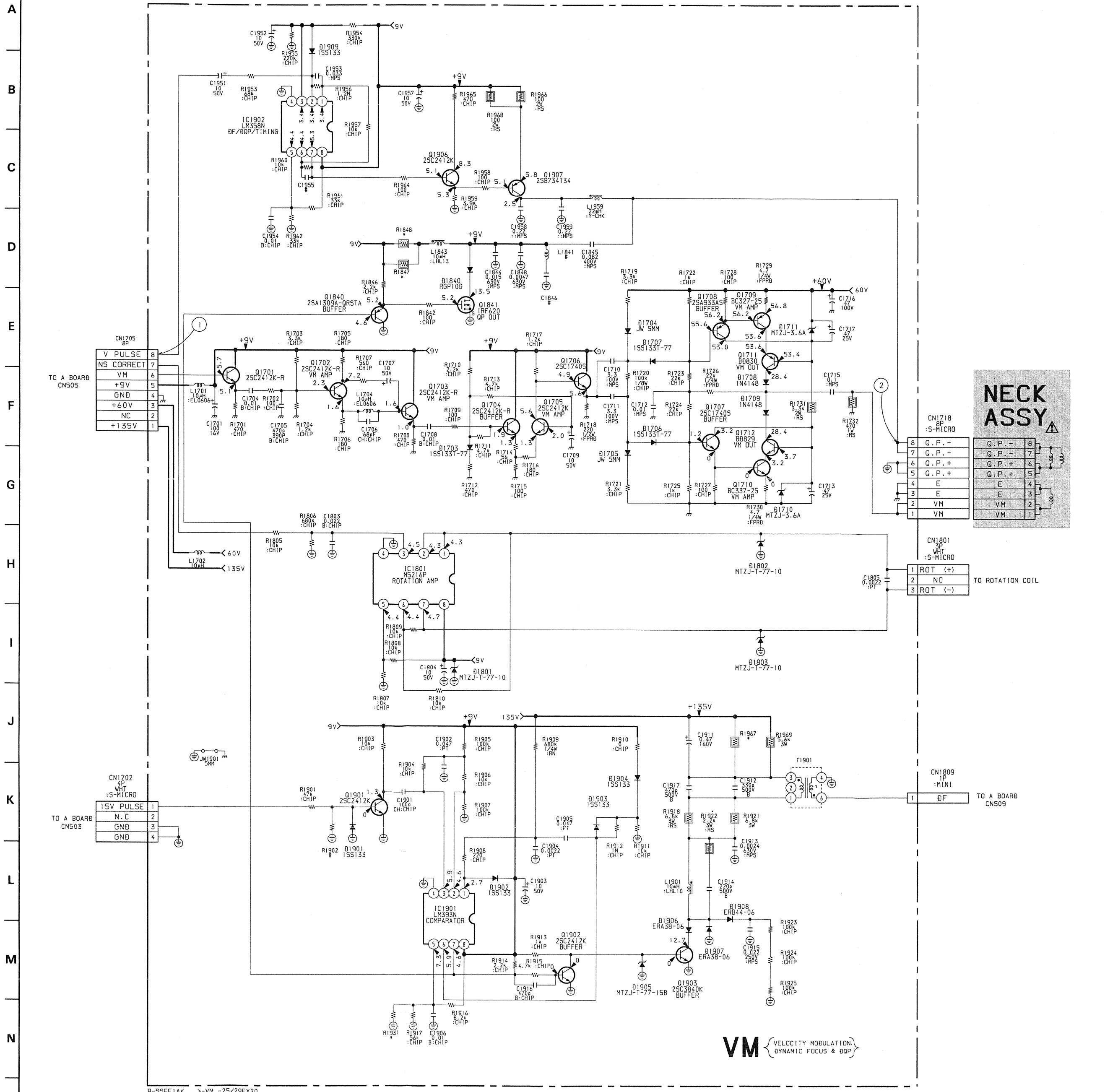

VM Board

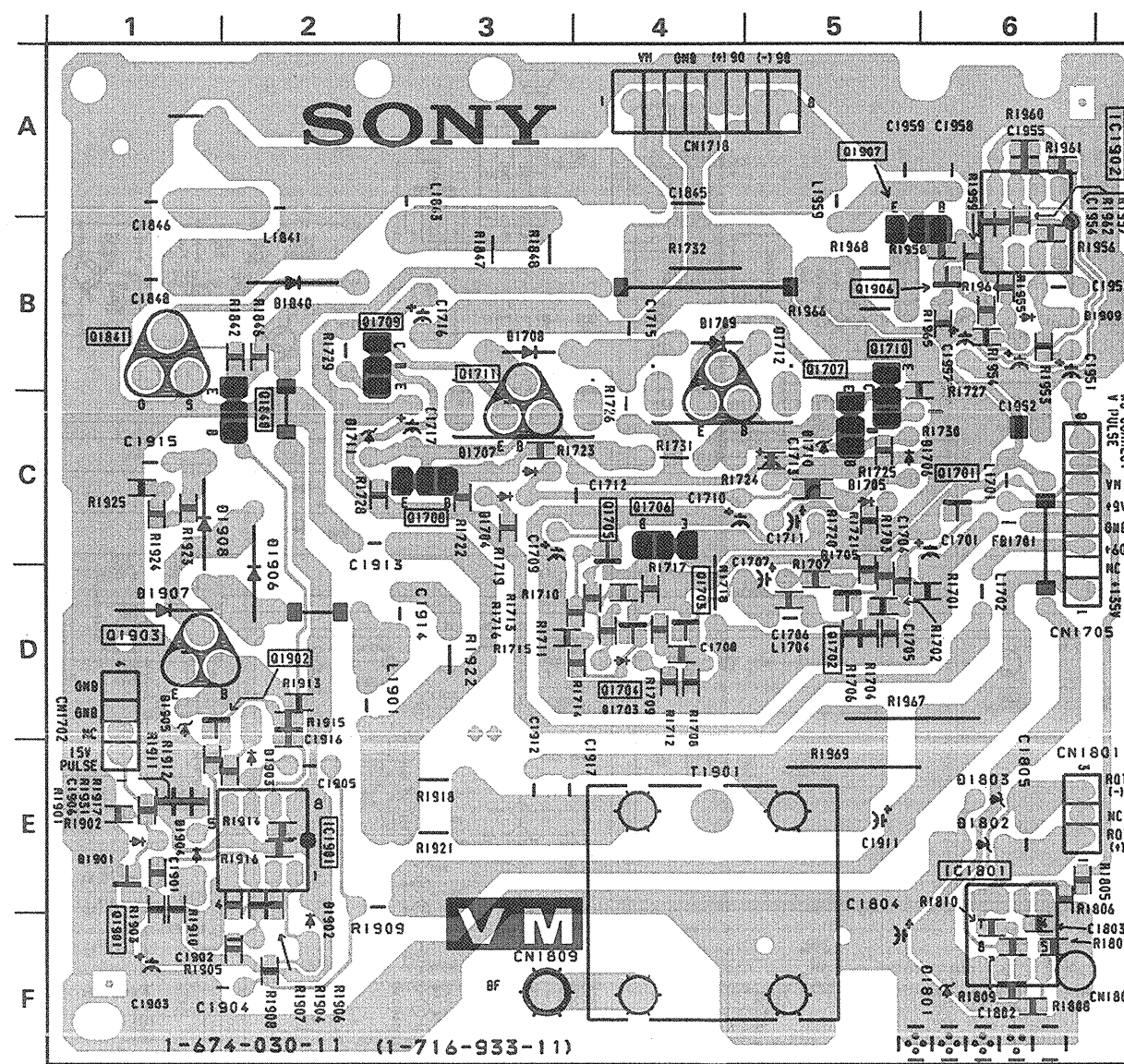

WAVEFORMS C BOARD

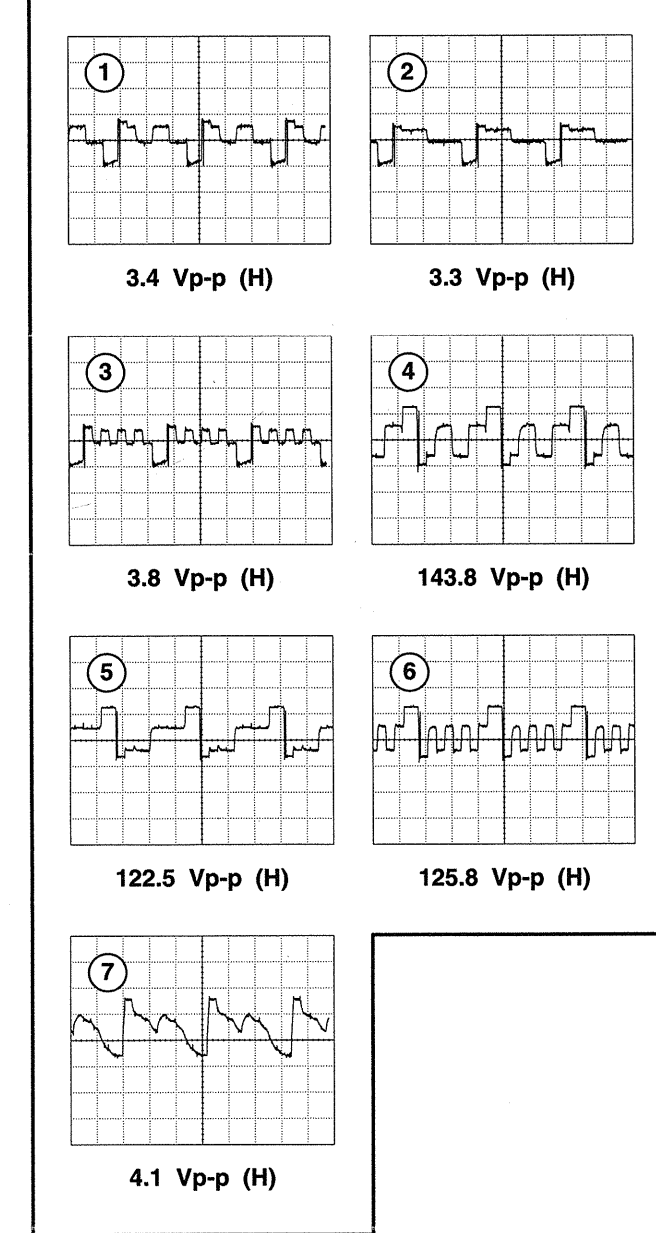

C Board

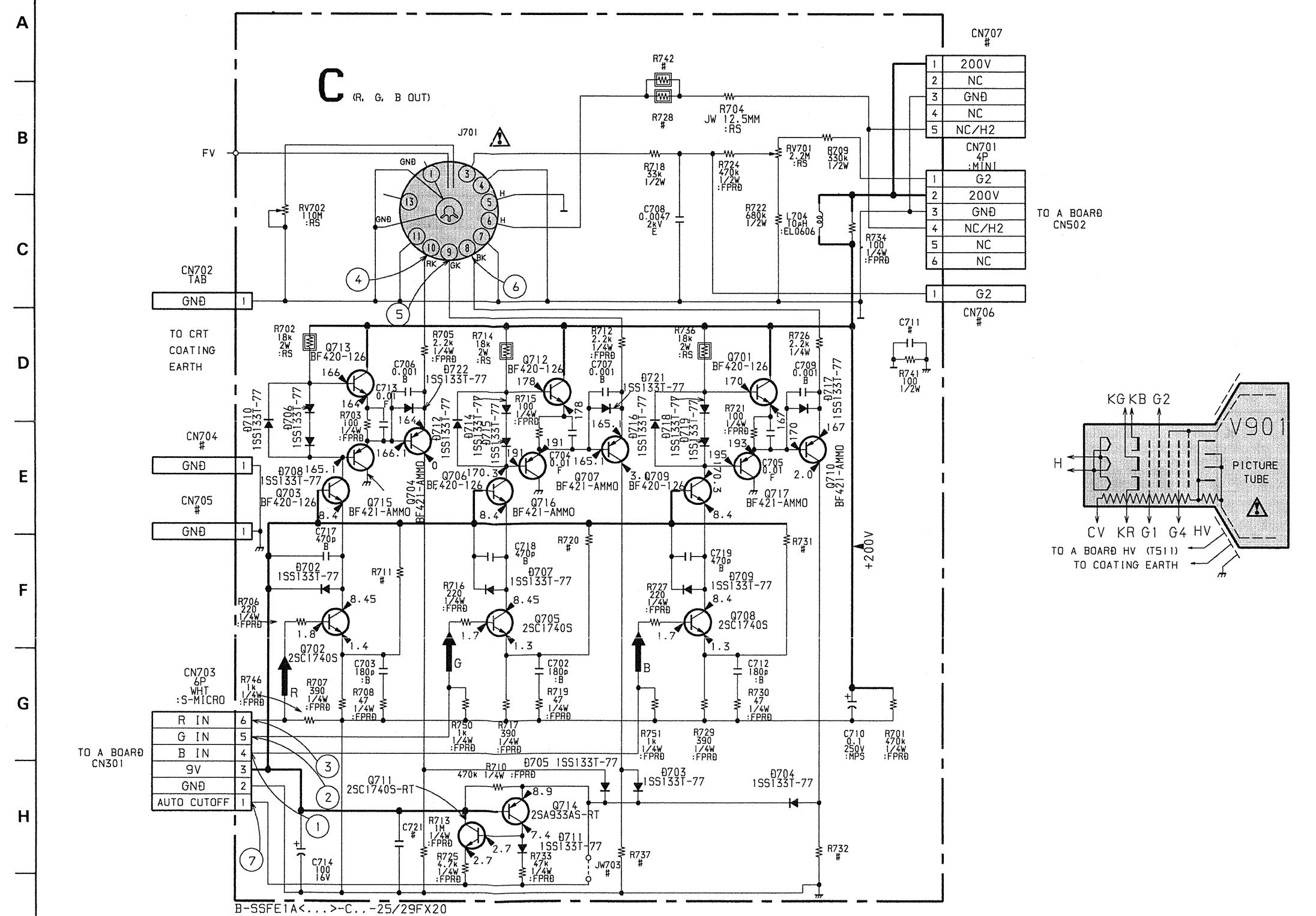
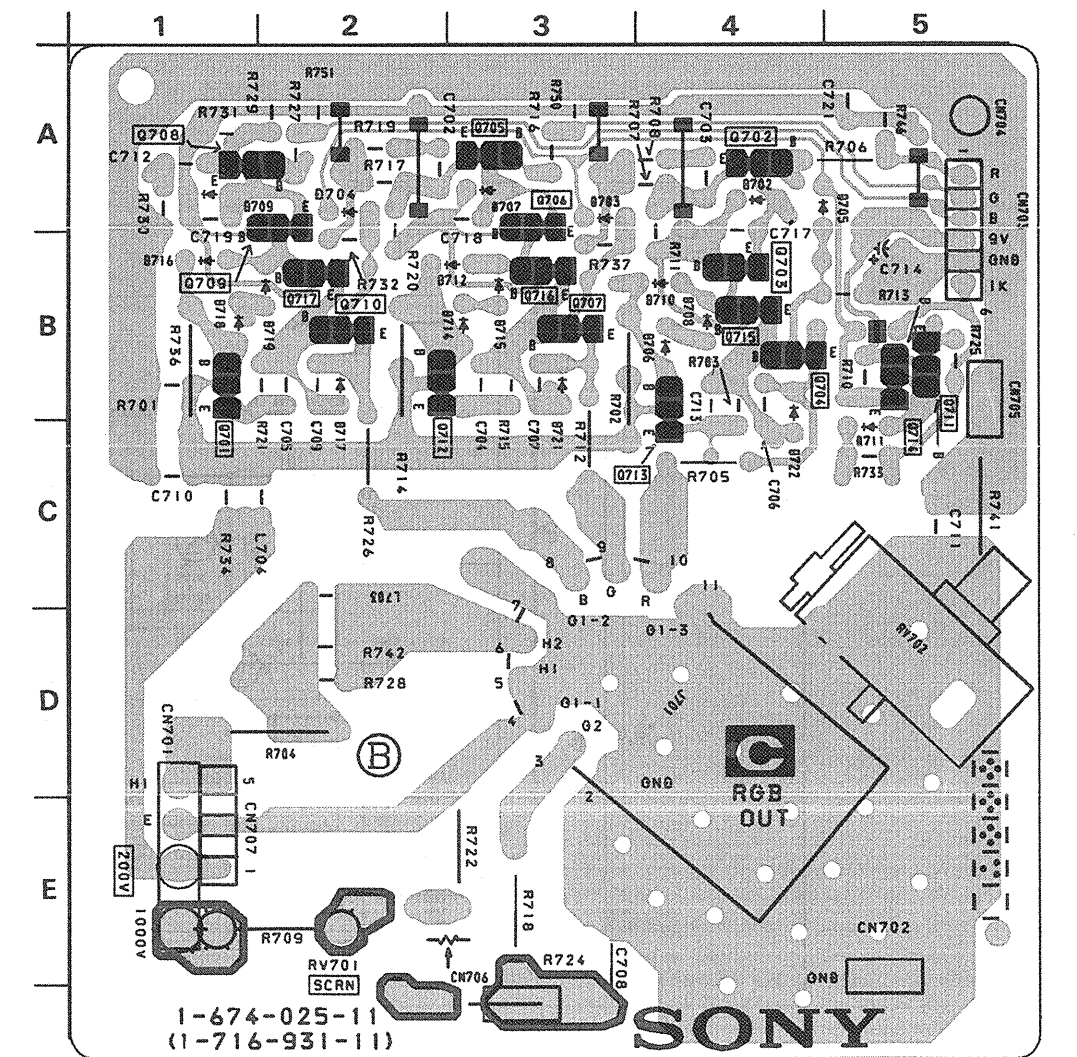

# 5-4. SEMICONDUCTORS (1)

LM358DR-EZ  
 NJM2233BL  
 NJM4558M-TE2  
 NJM2903D

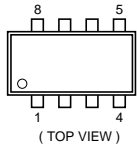

STV9379

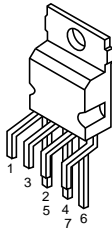

BF421-AMMO  
 2SA1091-O

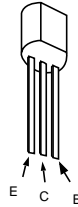

DTA144ESA  
 DTA144ESA-TP  
 DTC114EKA  
 DTC114EKA-T146  
 DTC143TKA-T146  
 DTC144EKA-T-146R  
 2SA1037K-T-146-R  
 R2SA1162-G  
 2SA1037K-T-146-QR  
 2SD601A-QTX  
 2SC1623-L5-L6  
 2SC2412K-QR  
 2SC2412K-T-146-R

LM393PN  
 TDA2822M  
 TEA2124

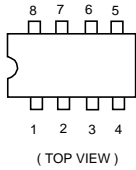

ST24W08FM6TR

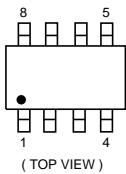

2SC688-LK

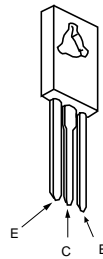

IRF614

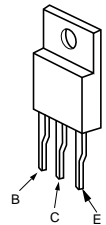
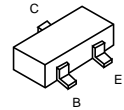

SBX1981-51

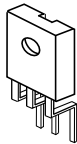

TDA7495

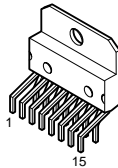

2SC4793



2SA933AS-QRT  
 2SAG33ASQT  
 2SA933AS-RT  
 2SC1740S-RT

SE-135N  
 SE135N-LF12

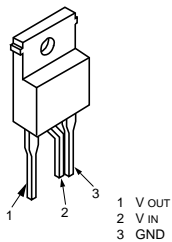

TDA9818-V1  
 TDA9817-V1

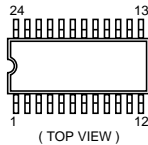

BF871-127

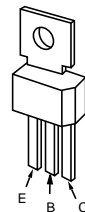

2SC2785-HFE

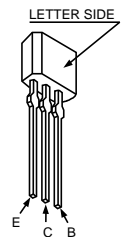

STR-F6654

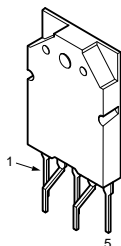

TOP209P

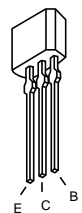
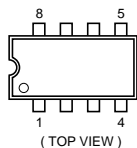

## 5-4. SEMICONDUCTORS (2)

2SK2251-01-F19

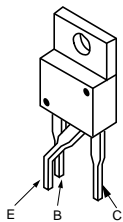

ERA81-004TP1	MTZJ-T-77-33A
ERA83-006	MTZJ-33C
MTZJ-3.6A	MTZJ-7.5B
MTZJ-T-77-2.2A	RD3.9ES-B2
HZS9.INBZ	RD5.6ESB2
MTZJ-T-77-3.9B	RD6.8ES-B2
MTZJ-T-77-5.6B	RD7.5ESB2
MTZJ-T-77-5.6C	RD9.1ES-B3
MTZJ-T-77-6.8A	RD10ESB2
MTZJ-T-77-6.8C	RD15ESB2
MTZJ-T-77-7.5C	1SS119-25
MTZJ-T-77-9.1A	1SS133T-77
MTZJ-T-77-10	

AK04-V1	ERD28-08S
AU-01Z-V1	ERC06-15SL
BYD33G	FMN-G12S
BYD33G-AMMO	GP08D
DINL20-TR	RG1CLF-B1
ERB44-06TP1	RGP10GPKG23
EGP20G	RU-3AM
EG-1Z-V1	RU3YX-LF-C4
EL1Z	RU3YX-V1
ERD28-06S	RU-4AM-T3
	1SS292T-77

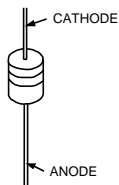

SLA-570KT3F

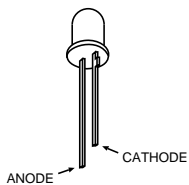

DAN202K  
DAN202K-T146

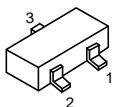

D4SB60L

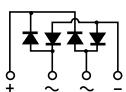
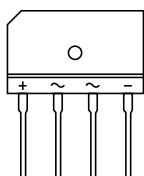

# 5-5. IC BLOCK DIAGRAMS

**A BOARD IC501 STV 9379**

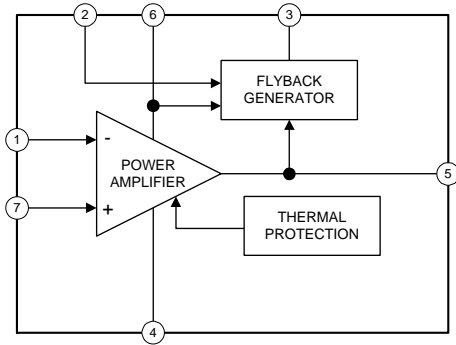

**A BOARD IC201 TDA7495**

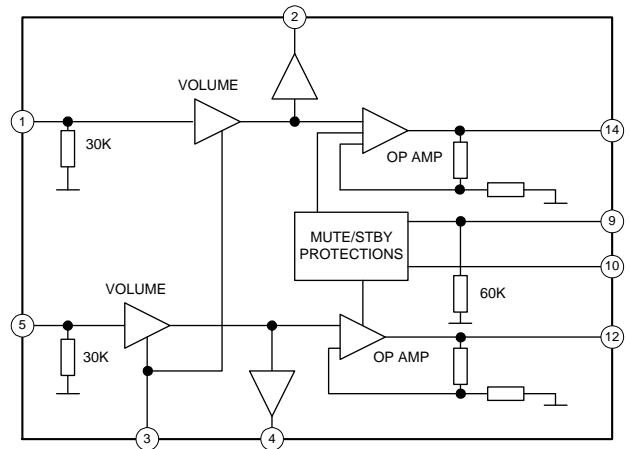

**A BOARD IC101 TDA9817/V1**

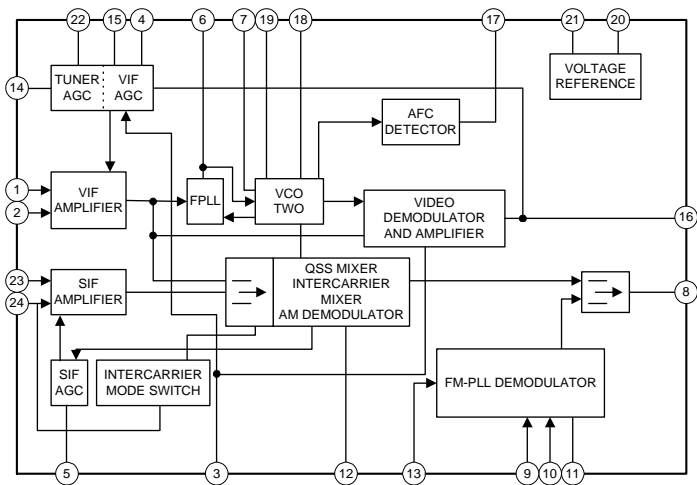

**A BOARD IC606 STR-F6654**

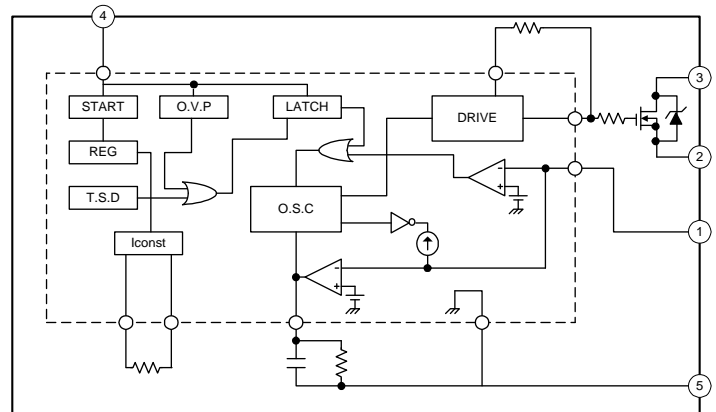

**A BOARD IC301 CXA2060AS**

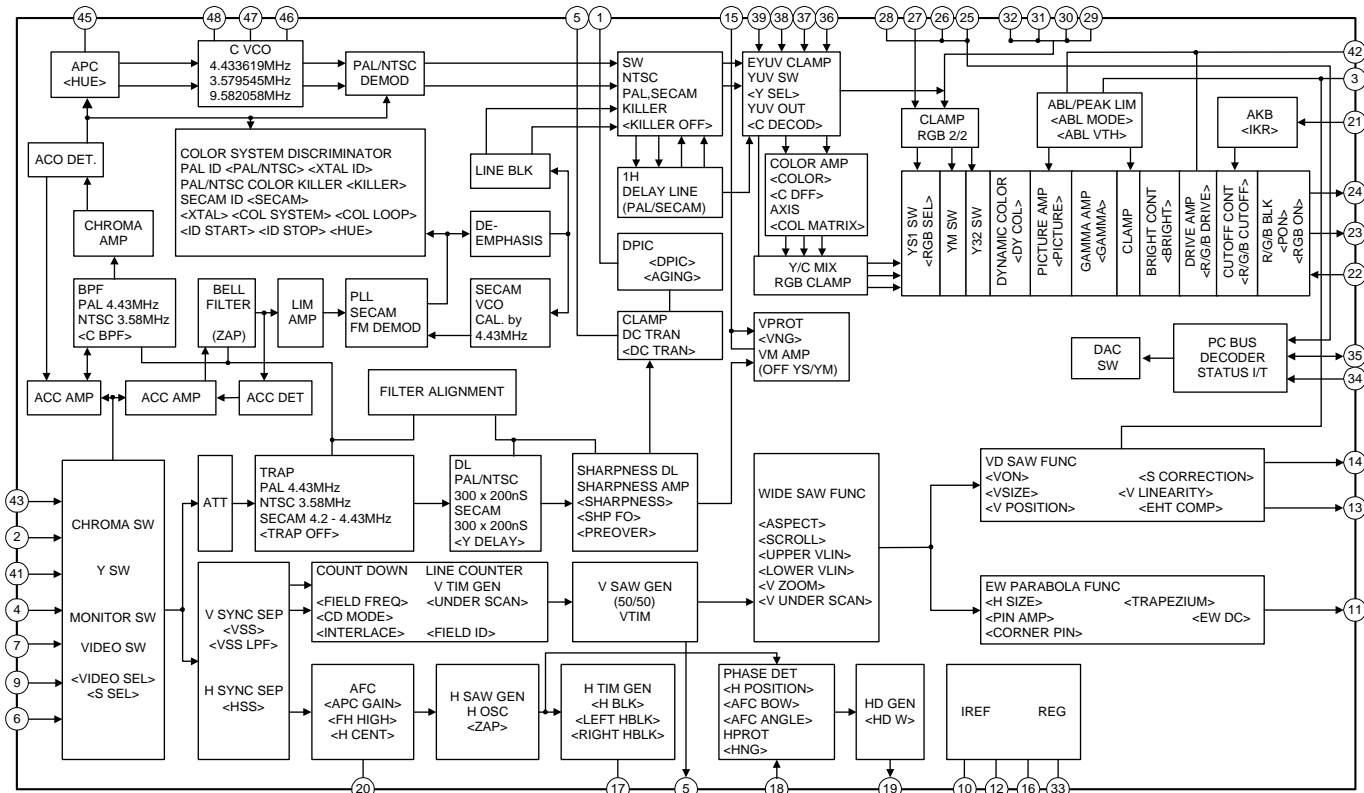



# SECTION 6 EXPLODED VIEWS

**Note :** Les composants identifiés par une trame et par une marque  $\Delta$  sont d'une importance critique pour la sécurité. Ne les remplacer que par des pièces du numéro spécifié.

**Note :** The components identified by shading and marked  $\Delta$  are critical for safety. Replace only with the part numbers specified in the parts list.

**NOTE :**

- Items with no part number and no description are not stocked because they are seldom required for routine service.
- The construction parts of an assembled part are indicated with a collation number in the remarks column.
- Items marked “ \* ” are not stocked since they are seldom required for routine service. Some delay should be anticipated when ordering these items.

**6-1. CHASSIS**

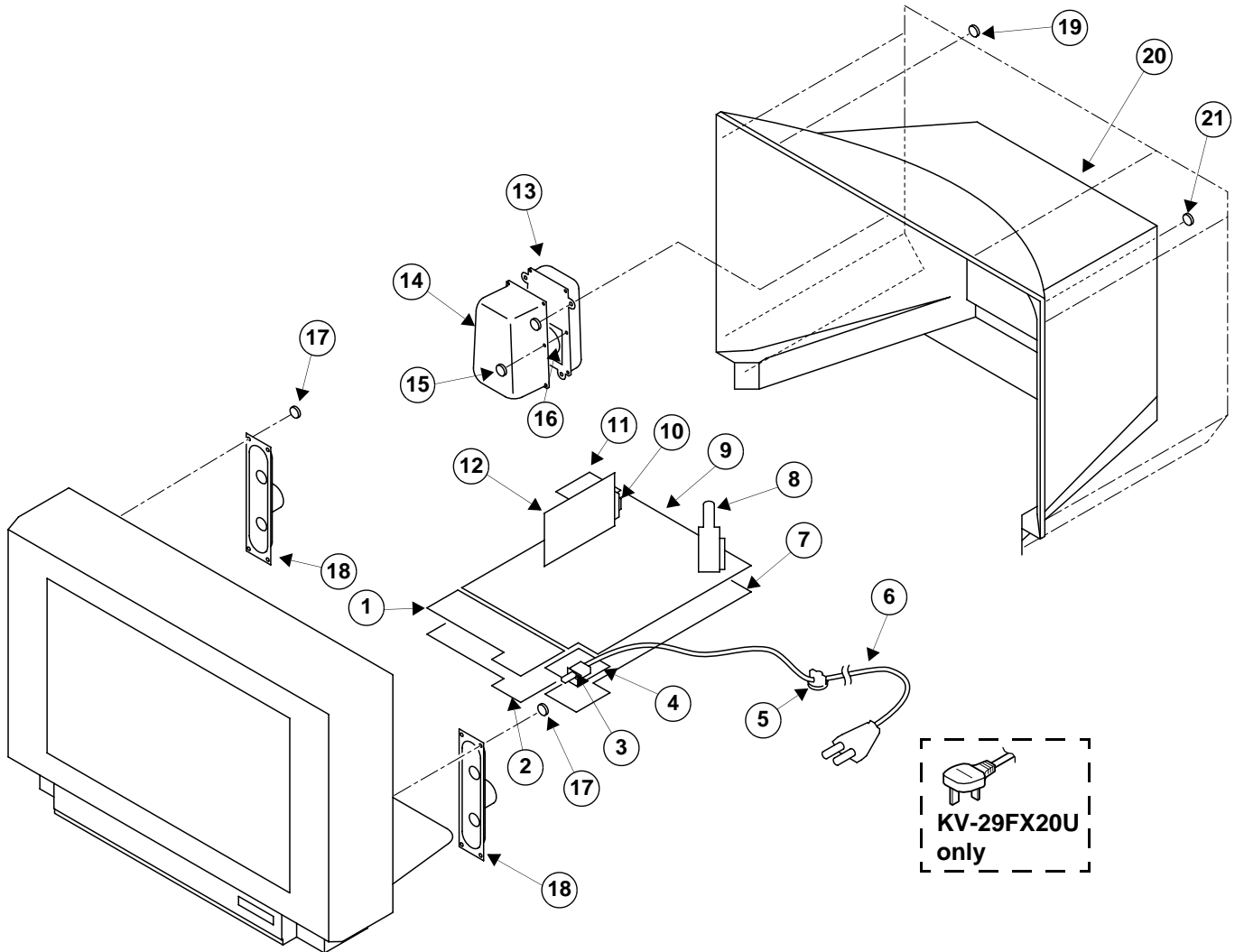

REF.NO.	PART.NO	DESCRIPTION	REMARK	REF.NO.	PART.NO	DESCRIPTION	REMARK
1	*A-1646-184-A	H BOARD, COMPLETE					
2	*4-204-744-01	BRACKET, H					
3	$\Delta$ 1-762-087-11	SWITCH, PUSH (AC POWER)					
4	*A-1624-080-A	F BOARD, COMPLETE					
5	*4-202-531-01	AC CORD LOCK (SC)					
6	$\Delta$ 1-765-286-11	CORD POWER (KV-25FX20/29FX20A/29FX20B/ KV-29FX20D/29FX20E/29FX20K/ KV-29FX20R)					
	$\Delta$ 1-776-860-12	CORD POWER FILTER UK (KV-29FX20U)					
7	*4-202-773-01	BRACKET, MAIN					
8	$\Delta$ 1-453-308-11	TRANSFORMER ASSY, FLYBACK (NX-4521/U2B4)					
9	*A-1632-843-A	A BOARD, COMPLETE (KV-25FX20A)					
	*A-1632-839-A	A BOARD, COMPLETE (KV-25FX20B)					
	*A-1632-842-A	A BOARD, COMPLETE (KV-25FX20D)					
	*A-1632-838-A	A BOARD, COMPLETE (KV-25FX20E)					
				10	8-598-432-00	TUNER (BTP-AC411)	
						(KV-25FX20A/25FX20D/25FX20E/25FX20K/ KV-25FX20R/29FX20A/29FX20D/29FX20E/ KV-29FX20K/29FX20R)	
					1-693-418-11	TUNER (TELE9-001A) (KV-25FX20B/29FX20B)	
					8-598-464-00	TUNER (BTP-AU611) (KV-29FX20U)	

REF. NO.	PART.NO	DESCRIPTION	REMARK	REF. NO.	PART.NO	DESCRIPTION	REMARK
11	*A-1649-023-A	K BOARD, COMPLETE		14	*4-204-776-01	BOX, WOOFER	
12	*A-1654-041-A	S1 BOARD, COMPLETE (KV-25FX20A/25FX20D/25FX20R/ KV-29FX20A/29FX20D/29FX20R)		15	7-685-663-71	SCREW + BVTP 4x16 TYPE IT-3	
	*A-1654-039-A	S1 BOARD, COMPLETE (KV-25FX20B/29FX20B)		16	1-529-408-11	LOUD SPEAKER 4.2 x 20cm	
	*A-1654-040-A	S1 BOARD, COMPLETE (KV-25FX20E/25FX20K/25FX20U/ KV-29FX20E/29FX20K/29FX20U)		17	4-384-096-01	SCREW 4x16, TAPPING, + P	
13	*4-204-775-01	BAFFLE, WOOFER		18	1-529-417-11	SPEAKER 8cm	
				19	7-685-663-71	SCREW +BVTP 4x16 TYPE 2 IT-3	
				20	4-204-804-01	COVER, REAR (KV-25FX20)	
					4-204-772-01	COVER, REAR (KV-29FX20)	
				21	7-685-663-79	SCREW +BVTP 4x16 TYPE 2 IT-3	

## 6-2. PICTURE TUBE

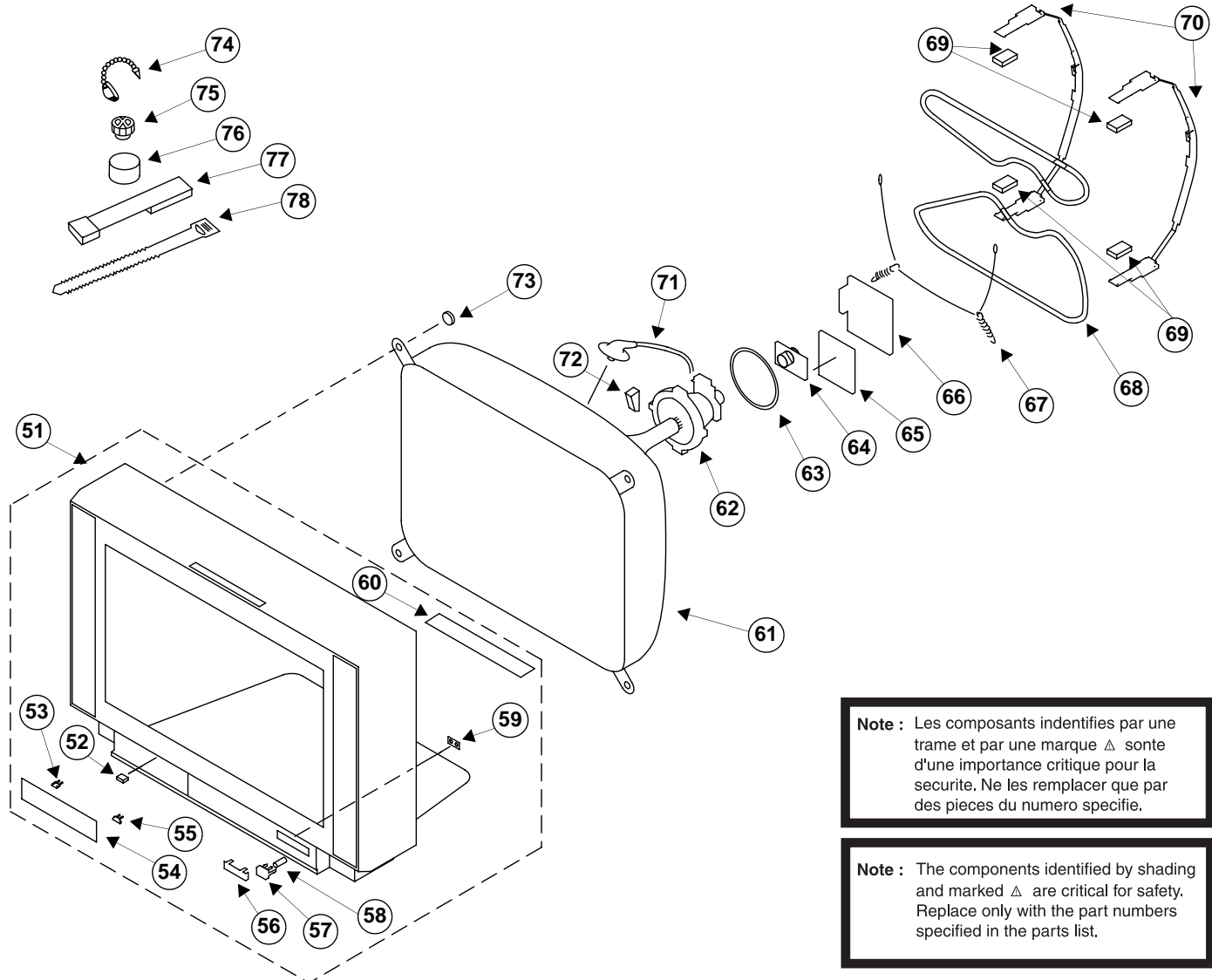

**Note :** Les composants indentifiés par une trame et par une marque  $\Delta$  sont d'une importance critique pour la sécurité. Ne les remplacer que par des pièces du numéro spécifique.

**Note :** The components identified by shading and marked  $\Delta$  are critical for safety. Replace only with the part numbers specified in the parts list.

REF.NO.	PART.NO	DESCRIPTION	REMARK
51	X-4200-481-1	BEZNET ASSY (KV-25FX20)	52-60
	X-4200-473-1	BEZNET ASSY (KV-29FX20)	52-60
	X-4200-473-2	BEZNET ASSY (KV-29FX201)	52-60
52	4-042-192-11	CATCHER, PUSH	
53	4-045-250-01	DAMPER	
54	4-204-770-01	DOOR, PAINTED	
		(KV-25FX20A/25FX20D/25FX20R/29FX20)	
	4-204-770-11	DOOR, PAINTED	
		(KV-25FX20B/25FX20E/25FX20K)	
55	3-703-035-11	SHAFT LID	
56	4-204-730-01	WINDOW ORNAMENTAL	
57	4-204-777-01	BUTTON, POWER	
58	4-204-426-01	SPRING	
59	4-204-785-01	GUIDE LIGHT	
60	4-204-666-01	SHEET, BLOTTING	
61	$\Delta$ 8-733-250-05	PICTURE TUBE (A60LPN70X) (KV-25FX20)	
	$\Delta$ 8-735-053-05	PICTURE TUBE (M68LNH060X) (KV-29FX20)	
62	$\Delta$ 1-451-475-11	DEFLECTION YOKE (Y25RSA) (KV-25FX20)	
	$\Delta$ 8-451-494-21	DEFLECTION YOKE (Y29RSA-M2) (KV-29FX20)	

REF.NO.	PART.NO	DESCRIPTION	REMARK
63	1-452-896-11	COIL, NA ROTATION (RT200)	
64	$\Delta$ 8-453-011-11	NECK ASSY, NA299-M	
65	*A-1674-141-A	VM BOARD, COMPLETE (KV-25FX20)	
	*A-1674-140-A	VM BOARD, COMPLETE (KV-29FX20)	
66	*A-1638-127-A	C BOARD, COMPLETE	
67	4-369-318-21	SPRING, TENSION	
68	$\Delta$ 1-419-142-11	COIL, DEGAUSSING (KV-25FX20)	
	$\Delta$ 1-416-654-11	COIL, DEMAGNETIC (KV-29FX20)	
69	4-203-390-11	CUSHION, DGC	
70	*4-204-812-01	HOLDER, DGC (KV-25FX20)	
	*4-204-768-01	HOLDER, DGC (KV-29FX20)	
71	$\Delta$ 1-251-317-31	CAP ASSY, HIGH VOLTAGE	
72	3-704-495-01	SPACER, DY	
73	4-302-404-03	SCREW (WASHER HEAD) (+P4x16)	
74	4-308-870-00	CLIP, LEAD WIRE	
75	1-452-094-00	MAGNET, ROTATABLE DISK; 15MM $\varnothing$	
76	1-425-032-00	MAGNET, DISK; 10MM $\varnothing$	
77	X-4387-214-1	PERMALLOY ASSY, CORRECTION	
78	3-701-007-00	BAND, BINDING	

# SECTION 7 ELECTRICAL PARTS LIST

## PARTS LISTING TABLE OF CONTENTS

	<u>Page</u>
<b>F BOARD COMPLETE Parts List :</b> .....	58
<b>A BOARD COMMON Parts List :</b> Parts common to all models listed in this manual .....	58
<b>A BOARD VARIANT Parts List :</b> Parts that belong only to the model specified	
<b><u>Model</u></b>	
KV-25FX20A/25FX20D/25FX20E KV-29FX20A/29FX20D/29FX20E .....	65
KV-25FX20B/29FX20B .....	66
KV-25FX20K/29FX20K .....	67
KV-25FX20R/29FX20R .....	68
KV-29FX20U .....	69
<b>C BOARD COMPLETE Parts List :</b> Parts common to all models listed in this manual .....	70
<b>VM BOARD COMMON Parts List :</b> Parts common to all models listed in this manual .....	71
<b>VM BOARD VARIANT Parts List :</b> Parts that belong only to the model specified	
<b><u>Model</u></b>	
KV-25FX20 .....	73
KV-29FX20 .....	73
<b>H BOARD COMPLETE Parts List :</b> .....	73
<b>K BOARD COMPLETE Parts List :</b> .....	74
<b>S1 BOARD COMMON Parts List :</b> Parts common to all models listed in this manual .....	74
<b>S1 BOARD VARIANT Parts List :</b> Parts that belong only to the model specified	
<b><u>Model</u></b>	
KV-25FX20A/25FX20D/25FX20R KV-29FX20A/29FX20D/29FX20R .....	75
KV-25FX20B/29FX20B .....	75
KV-25FX20E/25FX20K/ KV-29FX20E/29FX20K/29FX20U .....	76
<b>MISCELLANEOUS :</b> .....	76
<b>ACCESSORIES AND PACKAGING MATERIALS :</b> .....	76

**Note :** Refer to the designated variant parts list when seeking a part indicated by an asterisk (\*)

Parts indicated (#) on the Schematic Diagram are not used in this model and therefore do not appear in the Parts List.



The components identified by shading and marked  $\Delta$  are critical for safety  
 Replace only with the part number specified.

REF.NO. PART.NO DESCRIPTION REMARK

**\*A-1624-080-A F Board, Complete**

< CONNECTOR >

CN603	E *1-580-844-11	PIN, CONNECTOR (POWER)
CN604	E *1-691-292-11	PIN, CONNECTOR (PC BOARD) 3P

< FUSE >

F601	E 1-532-504-41	FUSE 4A/250V
	E *1-533-725-11	HOLDER, FUSE (F601)

< SWITCH >

S601	E 1-762-087-11	SWITCH, PUSH (AC POWER)
------	----------------	-------------------------

*A-1632-843-A	A Board, Complete	(KV-25FX20A)
*A-1632-839-A	A Board, Complete	(KV-25FX20B)
*A-1632-842-A	A Board, Complete	(KV-25FX20D)
*A-1632-838-A	A Board, Complete	(KV-25FX20E)
*A-1632-841-A	A Board, Complete	(KV-25FX20K)
*A-1632-844-A	A Board, Complete	(KV-25FX20R)
*A-1632-833-A	A Board, Complete	(KV-29FX20A)
*A-1632-832-A	A Board, Complete	(KV-29FX20B)
*A-1632-831-A	A Board, Complete	(KV-29FX20D)
*A-1632-830-A	A Board, Complete	(KV-29FX20E)
*A-1632-836-A	A Board, Complete	(KV-29FX20K)
*A-1632-835-A	A Board, Complete	(KV-29FX20R)
*A-1632-834-A	A Board, Complete	(KV-29FX20U)

**A Board Common Parts**

4-382-854-11 SCREW (M3X10), P, SW (+)

< CAPACITOR >

C005	1-163-105-00	CERAMIC CHIP 33PF	5%	50V
C006	1-163-105-00	CERAMIC CHIP 33PF	5%	50V
C009	1-128-551-11	ELECT 22MF	20%	25V
C010	1-126-960-11	ELECT 1MF	20%	50V
C011	1-126-965-11	ELECT 22MF	20%	50V
C013	1-163-017-00	CERAMIC CHIP 0.0047MF	10%	50V
C014	1-163-009-11	CERAMIC CHIP 0.001MF	10%	50V
C015	1-104-665-11	ELECT 100MF	20%	10V
C016	1-164-004-11	CERAMIC CHIP 0.1MF	10%	25V
C017	1-163-009-11	CERAMIC CHIP 0.001MF	10%	50V
C018	1-164-004-11	CERAMIC CHIP 0.1MF	10%	25V
C022	1-126-925-11	ELECT 470MF	20%	10V
C024	1-104-665-11	ELECT 100MF	20%	10V
C025	1-104-664-11	ELECT 47MF	20%	10V
C027	1-104-665-11	ELECT 100MF	20%	10V
C028	1-163-251-11	CERAMIC CHIP 100PF	5%	50V
C033	1-164-004-11	CERAMIC CHIP 0.1MF	10%	25V
C035	1-163-021-91	CERAMIC CHIP 0.01MF	10%	50V

REF.NO. PART.NO DESCRIPTION REMARK

C038	1-126-964-11	ELECT 10MF	20%	50V
C040	1-163-005-11	CERAMIC CHIP 470PF	10%	50V
C041	1-163-205-00	CERAMIC CHIP 0.001MF	10%	50V
C043	1-115-339-11	CERAMIC CHIP 0.1MF	10%	50V
C050	1-126-925-11	ELECT 470MF	20%	10V
C051	1-115-339-11	CERAMIC CHIP 0.1MF	10%	50V
C103	1-104-665-11	ELECT 100MF	20%	25V
C105	1-126-965-11	ELECT 22MF	20%	50V
C108	1-163-465-11	CERAMIC CHIP 9PF	0.25PF	50V
C109	1-164-004-11	CERAMIC CHIP 0.1MF	10%	25V
C110	1-163-038-91	CERAMIC CHIP 0.1MF		25V
C112	1-163-031-11	CERAMIC CHIP 0.01MF		50V
C115	1-164-489-11	CERAMIC CHIP 0.22MF	10%	16V
C116	1-126-961-11	ELECT 2.2MF	20%	50V
C117	1-126-961-11	ELECT 2.2MF	20%	50V
C118	1-163-038-91	CERAMIC CHIP 0.1MF		25V
C120	1-163-031-11	CERAMIC CHIP 0.01MF		50V
C129	1-104-664-11	ELECT 47MF	20%	16V
C134	1-128-551-11	ELECT 22MF	20%	25V
C135	1-164-004-11	CERAMIC CHIP 0.1MF	10%	25V
C138	1-165-319-11	CERAMIC CHIP 0.1MF		50V
C139	1-163-031-11	CERAMIC CHIP 0.01MF		50V
C143	1-104-664-11	ELECT 47MF	20%	25V
C146	1-163-031-11	CERAMIC CHIP 0.01MF		50V
C149	1-126-959-11	ELECT 0.47MF	20%	50V
C150	1-163-038-91	CERAMIC CHIP 0.1MF		25V
C151	1-163-017-00	CERAMIC CHIP 0.0047MF	10%	50V
C152	1-163-017-00	CERAMIC CHIP 0.0047MF	10%	50V
C160	1-163-017-00	CERAMIC CHIP 0.0047MF	10%	50V
C201	1-104-666-11	ELECT 220MF	20%	25V
C203	1-126-942-61	ELECT 1000MF	20%	25V
C204	1-126-942-61	ELECT 1000MF	20%	25V
C205	1-163-033-91	CERAMIC CHIP 0.022MF		50V
C206	1-126-960-11	ELECT 1MF	20%	50V
C207	1-126-972-11	ELECT 1000MF	20%	50V
C209	1-163-033-91	CERAMIC CHIP 0.022MF		50V
C213	1-163-019-00	CERAMIC CHIP 0.0068MF	10%	50V
C214	1-163-019-00	CERAMIC CHIP 0.0068MF	10%	50V
C217	1-164-004-11	CERAMIC CHIP 0.1MF	10%	25V
C240	1-163-031-11	CERAMIC CHIP 0.01MF		50V
C301	1-163-226-91	CERAMIC CHIP 9PF		16V
C302	1-104-664-11	ELECT 47MF	20%	16V
C303	1-163-021-91	CERAMIC CHIP 0.01MF	10%	50V
C304	1-126-964-11	ELECT 10MF	20%	50V
C308	1-164-004-11	CERAMIC CHIP 0.1MF	10%	25V
C309	1-164-506-11	CERAMIC CHIP 4.7MF		16V
C312	1-163-233-11	CERAMIC CHIP 18PF	5%	50V

The components identified by shading and marked  $\Delta$  are critical for safety  
 Replace only with the part number specified.

A

REF. NO.	PART.NO	DESCRIPTION	REMARK	REF. NO.	PART.NO	DESCRIPTION	REMARK
C313	1-163-233-11	CERAMIC CHIP 18PF	5% 50V	C518	1-106-375-12	MYLAR 0.022MF	10% 250V
C314	1-164-222-11	CERAMIC CHIP 0.22MF	25V	C519	1-163-275-11	CERAMIC CHIP 0.001MF	5% 50V
C316	1-163-259-91	CERAMIC CHIP 220PF	5% 50V	C520	1-163-038-91	CERAMIC CHIP 0.1MF	25V
C317	1-164-222-11	CERAMIC CHIP 0.22MF	25V	C522	1-130-495-00	FILM 0.1MF	5% 50V
C319	1-126-964-11	ELECT 10MF	20% 50V	C531	1-126-964-11	ELECT 10MF	20% 50V
C321	1-126-963-11	ELECT 4.7MF	20% 50V	C532	1-163-037-11	CERAMIC CHIP 0.022MF	10% 50V
C322	1-164-004-11	CERAMIC CHIP 0.1MF	10% 25V	C537	1-137-417-11	MYLAR 0.0047MF	10% 200V
C328	1-104-664-11	ELECT 47MF	20% 25V	C538	1-165-319-11	CERAMIC CHIP 0.1MF	50V
C329	1-163-021-91	CERAMIC CHIP 0.01MF	10% 50V	C539	1-111-230-11	ELECT 1MF	20% 160V
C330	1-163-038-91	CERAMIC CHIP 0.1MF	25V	C540	1-136-206-11	FILM 0.033MF	10% 400V
C331	1-163-021-91	CERAMIC CHIP 0.01MF	10% 50V	C541	1-106-383-00	MYLAR 0.047MF	10% 200V
C332	1-163-021-91	CERAMIC CHIP 0.01MF	10% 50V	C542	1-161-754-00	CERAMIC 0.001MF	10% 2KV
C333	1-126-960-11	ELECT 1MF	20% 50V	C543	1-162-134-11	CERAMIC 470PF	10% 2KV
C334	1-163-017-00	CERAMIC CHIP 0.0047MF	10% 50V	C545	1-126-960-11	ELECT 1MF	20% 50V
C335	1-163-021-91	CERAMIC CHIP 0.01MF	10% 50V	C547	1-115-521-11	FILM 0.82MF	5% 250V
C336	1-163-021-91	CERAMIC CHIP 0.01MF	10% 50V	C548	1-162-134-11	CERAMIC 470PF	10% 2KV
C337	1-163-021-91	CERAMIC CHIP 0.01MF	10% 50V	C550	1-107-638-11	ELECT 33MF	20% 160V
C338	1-126-967-11	ELECT 47MF	20% 50V	C552	1-102-212-00	CERAMIC 820PF	10% 500V
C339	1-163-226-91	CERAMIC CHIP 9PF	16V	C571	1-123-024-21	ELECT 33MF	160V
C350	1-163-017-00	CERAMIC CHIP 0.0047MF	10% 50V	C580	1-163-021-91	CERAMIC CHIP 0.01MF	10% 50V
C351	1-163-017-00	CERAMIC CHIP 0.0047MF	10% 50V	C584	1-126-963-11	ELECT 4.7MF	20% 50V
C401	1-163-009-11	CERAMIC CHIP 0.001MF	10% 50V	C601	£ 1-107-563-11	FILM 0.1MF	20% 300V
C402	1-126-964-11	ELECT 10MF	20% 50V	C602	£ 1-107-563-11	FILM 0.1MF	20% 300V
C403	1-126-964-11	ELECT 10MF	20% 50V	C603	£ 1-119-888-51	CERAMIC 0.0022MF	99% 250V
C405	1-163-009-11	CERAMIC CHIP 0.001MF	10% 50V	C604	£ 1-119-888-51	CERAMIC 0.0022MF	99% 250V
C408	1-126-964-11	ELECT 10MF	20% 50V	C605	1-104-665-11	ELECT 100MF	20% 10V
C409	1-126-960-11	ELECT 1MF	20% 50V	C607	1-161-754-00	CERAMIC 0.001MF	10% 2KV
C411	1-126-964-11	ELECT 10MF	20% 50V	C609	1-128-550-11	ELECT 2200MF	20% 50V
C413	1-163-009-11	CERAMIC CHIP 0.001MF	10% 50V	C610	1-104-665-11	ELECT 100MF	20% 25V
C417	1-163-009-11	CERAMIC CHIP 0.001MF	10% 50V	C611	1-165-127-11	CERAMIC 470PF	10% 500V
C430	1-104-664-11	ELECT 47MF	20% 25V	C612	£ 1-161-964-51	CERAMIC 0.0047MF	250V
C432	1-163-141-00	CERAMIC CHIP 0.001MF	5% 50V	C613	£ 1-161-964-51	CERAMIC 0.0047MF	250V
C433	1-163-141-00	CERAMIC CHIP 0.001MF	5% 50V	C614	£ 1-161-964-51	CERAMIC 0.0047MF	250V
C434	1-126-935-11	ELECT 470MF	20% 16V	C615	1-130-202-00	FILM 0.022MF	10% 400V
C501	1-126-968-11	ELECT 100MF	20% 50V	C616	1-162-318-11	CERAMIC 0.001MF	10% 500V
C502	1-163-038-91	CERAMIC CHIP 0.1MF	25V	C618	1-107-890-51	ELECT 2200MF	20% 25V
C503	1-126-968-11	ELECT 100MF	20% 50V	C621	1-163-005-11	CERAMIC CHIP 470PF	10% 50V
C504	1-106-220-00	MYLAR 0.1MF	10% 100V	C622	£ 1-161-964-51	CERAMIC 0.0047MF	250V
C505	1-137-194-81	FILM 0.47MF	5% 50V	C623	1-107-364-11	MYLAR 0.01MF	10% 400V
C506	1-163-021-91	CERAMIC CHIP 0.01MF	10% 50V	C624	1-104-665-11	ELECT 100MF	20% 10V
C507	1-126-933-11	ELECT 100MF	20% 16V	C625	1-104-665-11	ELECT 100MF	20% 25V
C508	1-126-960-11	ELECT 1MF	20% 50V	C628	1-124-347-00	ELECT 100MF	20% 160V
C509	1-107-364-11	MYLAR 0.01MF	10% 200V	C630	1-165-127-11	CERAMIC 470PF	10% 500V
C512	1-162-114-00	CERAMIC 0.0047MF	2KV	C633	1-104-332-11	CERAMIC 470PF	10% 2KV
C513	1-107-662-11	ELECT 22MF	20% 250V	C638	1-107-679-11	ELECT 10MF	20% 450V
C515	1-104-666-11	ELECT 220MF	20% 25V	C639	1-104-665-11	ELECT 100MF	20% 25V
C517	1-104-666-11	ELECT 220MF	20% 25V	C640	1-104-664-11	ELECT 47MF	20% 10V



The components identified by shading and marked **△** are critical for safety. Replace only with the part number specified.

REF. NO.	PART.NO	DESCRIPTION	REMARK	REF. NO.	PART.NO	DESCRIPTION	REMARK
C641	1-111-034-11	ELECT	220MF 20% 16V	D202	8-719-914-43	DIODE DAN202K	
C642	1-104-665-11	ELECT	100MF 20% 10V	D203	8-719-914-43	DIODE DAN202K	
C643	1-165-127-11	CERAMIC	470PF 10% 500V	D204	8-719-109-89	DIODE RD5.6ESB2	
C654	1-107-932-11	ELECT	47MF 20% 100V	D205	8-719-109-89	DIODE RD5.6ESB2	
< FILTER >				D206	8-719-109-89	DIODE RD5.6ESB2	
CF101	1-404-134-00	TRAP, CERAMIC (5.5MHZ)		D306	8-719-109-89	DIODE RD5.6ESB2	
SWF102	1-767-873-11	FILTER, SURFACE WAVE		D307	8-719-109-89	DIODE RD5.6ESB2	
< CONNECTOR >				D320	8-719-929-15	DIODE HZS9.1NB2	
CN001	*1-568-882-51	PIN, CONNECTOR 7P		D402	8-719-421-59	DIODE MA3130WA-TX	
CN007	*1-568-882-51	PIN, CONNECTOR 7P		D403	8-719-421-59	DIODE MA3130WA-TX	
CN201	*1-564-507-11	PLUG, CONNECTOR 4P		D404	8-719-421-59	DIODE MA3130WA-TX	
CN202	*1-564-508-11	PLUG, CONNECTOR 5P		D405	8-719-109-89	DIODE RD5.6ESB2	
CN203	*1-766-957-11	CONNECTOR, BOARD TO BOARD 20P		D406	8-719-109-97	DIODE RD6.8ESB2	
CN208	*1-564-509-11	PLUG, CONNECTOR 6P		D407	8-719-109-97	DIODE RD6.8ESB2	
CN301	*1-564-509-11	PLUG, CONNECTOR 6P		D408	8-719-929-15	DIODE HZS9.1NB2	
CN406	*1-564-511-11	PLUG, CONNECTOR 8P		D409	8-719-421-59	DIODE MA3130WA-TX	
CN501	*1-580-798-11	CONNECTOR PIN (DY)		D410	8-719-421-59	DIODE MA3130WA-TX	
CN502	1-784-633-11	PIN, CONNECTOR 4P		D411	8-719-421-59	DIODE MA3130WA-TX	
CN503	*1-564-507-11	PLUG, CONNECTOR 4P		D414	8-719-923-84	DIODE MTZJ-T-77-13B	
CN505	*1-564-511-11	PLUG, CONNECTOR 8P		D416	8-719-421-59	DIODE MA3130WA-TX	
CN506	1-695-915-11	TAB (CONTACT)		D418	8-719-929-15	DIODE HZS9.1NB2	
CN509	1-695-915-21	TAB CONTACT		D419	8-719-929-15	DIODE HZS9.1NB2	
CN602	E 1-508-765-00	PIN, CONNECTOR (5MM PITCH) 3P		D420	8-719-109-97	DIODE RD6.8ESB2	
CN603	E *1-508-786-00	PIN, CONNECTOR (5MM PITCH) 2P		D421	8-719-421-59	DIODE MA3130WA-TX	
CN606	E *1-691-292-11	PIN, CONNECTOR (PC BOARD) 3P		D422	8-719-923-84	DIODE MTZJ-T-77-13B	
< DIODE >				D423	8-719-109-97	DIODE RD6.8ESB2	
D001	8-719-109-89	DIODE RD5.6ESB2		D424	8-719-929-15	DIODE HZS9.1NB2	
D002	8-719-109-89	DIODE RD5.6ESB2		D427	8-719-109-97	DIODE RD6.8ESB2	
D004	8-719-109-89	DIODE RD5.6ESB2		D430	8-719-929-15	DIODE HZS9.1NB2	
D007	8-719-109-89	DIODE RD5.6ESB2		D501	8-719-302-43	DIODE EL1Z	
D008	8-719-991-33	DIODE 1SS133T-77		D502	8-719-924-13	DIODE MTZJ-T-77-22B	
D010	8-719-109-89	DIODE RD5.6ESB2		D511	8-719-028-72	DIODE RGP02-17EL-6433	
D011	8-719-109-89	DIODE RD5.6ESB2		D512	8-719-302-43	DIODE EL1Z	
D013	8-719-109-89	DIODE RD5.6ESB2		D513	8-719-979-85	DIODE EGP20G	
D015	8-719-914-43	DIODE DAN202K		D514	8-719-979-85	DIODE EGP20G	
D017	8-719-109-89	DIODE RD5.6ESB2		D534	8-719-302-43	DIODE EL1Z	
D018	8-719-991-33	DIODE 1SS133T-77		D535	8-719-908-03	DIODE GP08D	
D019	8-719-914-43	DIODE DAN202K		D536	8-719-945-80	DIODE ERC06-15S	
D023	8-719-109-89	DIODE RD5.6ESB2		D538	8-719-908-03	DIODE GP08D	
D098	8-719-982-96	DIODE MTZJ-T-77-2.2A		D539	8-719-312-10	DIODE RU4AM-T3	
D099	8-719-982-96	DIODE MTZJ-T-77-2.2A		D541	1-535-303-00	LEAD, JUMPER (5.0MM)	
D101	8-719-982-24	DIODE MTZJ-33A		D571	8-719-911-19	DIODE 1SS119-25	
D201	8-719-929-15	DIODE HZS9.1NB2		D601	8-719-510-53	DIODE D4SB60L	
				D602	8-719-046-74	DIODE AU-01Z-V1	
				D603	8-719-046-74	DIODE AU-01Z-V1	
				D605	8-719-312-10	DIODE RU4AM-T3	
				D608	8-719-067-88	DIODE RG1CLF-B1	

The components identified by shading and marked  $\Delta$  are critical for safety  
 Replace only with the part number specified.

A

REF. NO.	PART.NO	DESCRIPTION	REMARK	REF. NO.	PART.NO	DESCRIPTION	REMARK
D610	8-719-067-78	DIODE RN3Z-LF014-302				< COIL >	
D613	8-719-911-19	DIODE 1SS119-25					
D619	8-719-043-76	DIODE AK04V0		L102	1-414-182-11	INDUCTOR	6.8UH
D620	8-719-046-74	DIODE AU-01Z-V1		L103	1-408-603-21	INDUCTOR	10UH
D621	8-719-068-00	DIODE ERC04-06SE		L104	1-408-603-21	INDUCTOR	10UH
				L105	1-408-603-41	INDUCTOR	10UH
D626	8-719-068-00	DIODE ERC04-06SE		L106	1-414-187-11	INDUCTOR	47UH
D627	8-719-063-73	DIODE D1NL20U-TR					
D629	8-719-073-23	DIODE ST02D-200TA		L110	1-408-611-31	INDUCTOR	47UH
D630	8-719-110-67	DIODE RD27ESB2		L111	1-408-611-31	INDUCTOR	47UH
D631	8-719-921-63	DIODE MTZJ-7.5B		L118	1-216-295-91	SHORT	0
				L201	1-414-177-11	INDUCTOR	1UH
D632	8-719-032-12	DIODE D1NS6		L202	1-414-177-11	INDUCTOR	1UH
D633	8-719-109-89	DIODE RD5.6ESB2					
D634	8-719-067-78	DIODE RN3Z-LF014-302		L203	1-406-979-11	INDUCTOR	220UH
D654	8-719-302-43	DIODE EL1Z		L301	1-216-295-91	SHORT	0
		< FERRITE BEAD >		L302	1-414-187-11	INDUCTOR	47UH
FB601	1-412-911-11	FERRITE	0UH	L303	1-414-186-31	INDUCTOR	33UH
FB602	1-412-911-11	FERRITE	0UH	L401	1-414-187-11	INDUCTOR	47UH
FB605	1-410-397-21	FERRITE	1.1UH	L402	1-408-611-31	INDUCTOR	47UH
FB608	1-412-911-11	FERRITE	0UH	L405	1-412-002-31	INDUCTOR CHIP	4.7UH
FB609	1-410-396-41	FERRITE	0.45UH	L406	1-412-002-31	INDUCTOR CHIP	4.7UH
				L407	1-412-002-31	INDUCTOR CHIP	4.7UH
FB610	1-410-397-21	FERRITE	1.1UH	L408	1-412-002-31	INDUCTOR CHIP	4.7UH
FB611	1-410-397-21	FERRITE	1.1UH				
		< IC >		L434	1-414-181-11	INDUCTOR	4.7UH
IC001	8-759-598-33	IC SAA5564PS		L435	1-414-181-11	INDUCTOR	4.7UH
IC003	8-759-336-46	IC PST574D-T		L447	1-410-993-42	INDUCTOR CHIP	1UH
IC004	8-759-527-76	IC M24C08-MN6T		L501	1-414-187-11	INDUCTOR	47UH
IC201	8-759-442-74	IC TDA7495		L502	1-412-529-11	INDUCTOR	22UH
IC301	8-752-091-76	IC CXA2140S					
				L503	1-412-521-31	INDUCTOR	4.7UH
IC401	8-759-064-91	IC NJM2233BL		L504	1-535-303-00	LEAD, JUMPER	(5.0MM)
IC501	8-759-192-71	IC STV9379		L532	1-412-553-11	INDUCTOR	3.3MMH
IC531	8-759-450-95	IC LM393N		L533	1-406-989-21	INDUCTOR	10MMH
IC603	8-749-920-61	IC SE-135N		L535	1-459-111-00	INDUCTOR	10MMH
IC604	8-759-572-80	IC L7805CV/LS0					
				L571	1-412-533-21	INDUCTOR	47UH
IC605	8-759-574-79	IC L7809CV/LS0		L602	1-535-143-61	LEAD, JUMPER	(5.0MM)
IC606	8-749-016-20	IC STR-F6654-LF1357					
IC607	8-759-591-02	IC L78L33ABZ					
IC608	8-759-925-54	IC LM2940CT-5.0					
IC609	8-759-468-89	IC TOP209Y					
		< SOCKET >					
J401	*1-766-296-31	CONNECTOR, DUAL SCART					
J404	1-784-632-11	JACK, PIN 2P					
						< PHOTO COUPLER >	
				PH601	E 8-749-016-21	IC TCET1103G	
						< IC LINK >	
				PS627	E 1-532-727-11	LINK, IC 0.25A (ICP-N5)	
						< TRANSISTOR >	
				Q001	1-801-806-11	TRANSISTOR DTC144EKA	
				Q010	8-729-120-28	TRANSISTOR 2SC1623-L5L6	
				Q011	1-801-806-11	TRANSISTOR DTC144EKA	
				Q012	8-729-422-33	TRANSISTOR 2SD601A-Q-TX	
				Q013	8-729-120-28	TRANSISTOR 2SC1623-L5L6	





REF. NO.	PART. NO	DESCRIPTION	REMARK	REF. NO.	PART. NO	DESCRIPTION	REMARK
0016	8-729-920-72	TRANSISTOR 2SA1037K-T-146-QR		R019	1-216-295-91	SHORT	0
0017	8-729-920-72	TRANSISTOR 2SA1037K-T-146-QR		R020	1-216-049-91	RES, CHIP	1K 5% 1/10W
0018	8-729-120-28	TRANSISTOR 2SC1623-L5L6		R021	1-216-065-91	RES, CHIP	4.7K 5% 1/10W
0019	8-729-120-28	TRANSISTOR 2SC1623-L5L6		R022	1-216-049-91	RES, CHIP	1K 5% 1/10W
0020	8-729-120-28	TRANSISTOR 2SC1623-L5L6		R023	1-216-049-91	RES, CHIP	1K 5% 1/10W
0021	8-729-920-72	TRANSISTOR 2SA1037K-T-146-QR		R024	1-216-073-00	RES, CHIP	10K 5% 1/10W
0022	8-729-120-28	TRANSISTOR 2SC1623-L5L6		R025	1-216-073-00	RES, CHIP	10K 5% 1/10W
0101	8-729-920-72	TRANSISTOR 2SA1037K-T-146-QR		R026	1-216-073-00	RES, CHIP	10K 5% 1/10W
0111	1-801-806-11	TRANSISTOR DTC144EKA-T146		R027	1-216-083-00	RES, CHIP	27K 5% 1/10W
0112	8-729-920-72	TRANSISTOR 2SA1037K-T-146-QR		R028	1-216-049-91	RES, CHIP	1K 5% 1/10W
Q201	8-729-920-75	TRANSISTOR 2SC2412K		R029	1-216-073-00	RES, CHIP	10K 5% 1/10W
Q202	8-729-422-33	TRANSISTOR 2SD601A-Q-TX		R030	1-216-073-00	RES, CHIP	10K 5% 1/10W
Q328	8-729-120-28	TRANSISTOR 2SC1623-L5L6		R031	1-216-073-00	RES, CHIP	10K 5% 1/10W
Q329	8-729-920-72	TRANSISTOR 2SA1037K-T-146-QR		R032	1-216-089-91	RES, CHIP	47K 5% 1/10W
Q405	8-729-120-28	TRANSISTOR 2SC1623-L5L6		R033	1-216-093-91	RES, CHIP	68K 5% 1/10W
Q417	8-729-920-72	TRANSISTOR 2SA1037K-T-146-QR		R034	1-216-049-91	RES, CHIP	1K 5% 1/10W
Q418	8-729-422-33	TRANSISTOR 2SD601A-Q-TX		R035	1-216-198-91	RES, CHIP	1K 5% 1/8W
Q501	8-729-422-33	TRANSISTOR 2SD601A-Q-TX		R036	1-216-065-91	RES, CHIP	4.7K 5% 1/10W
Q532	8-729-038-83	TRANSISTOR 2SK2251-01-F19		R037	1-216-081-00	RES, CHIP	22K 5% 1/10W
Q533	8-729-049-08	TRANSISTOR BU2515DX-127		R038	1-216-222-00	RES, CHIP	10K 5% 1/8W
Q535	8-729-119-80	TRANSISTOR 2SC2688-LK		R039	1-216-214-00	RES, CHIP	4.7K 5% 1/8W
Q571	8-729-105-08	TRANSISTOR 2SA1330-06		R040	1-216-295-91	SHORT	0
Q574	8-729-422-33	TRANSISTOR 2SD601A-Q-TX		R050	1-216-049-91	RES, CHIP	1K 5% 1/10W
Q575	1-801-806-11	TRANSISTOR DTC144EKA-T146		R051	1-216-174-00	RES, CHIP	100 5% 1/8W
Q576	8-729-422-33	TRANSISTOR 2SD601A-Q-TX		R052	1-216-295-91	SHORT	0
Q601	8-729-920-72	TRANSISTOR 2SA1037K-T-146-QR		R053	1-216-065-91	RES, CHIP	4.7K 5% 1/10W
		< RESISTOR >		R054	1-216-097-91	RES, CHIP	100K 5% 1/10W
JR124	1-216-295-91	SHORT	0	R060	1-216-025-91	RES, CHIP	100 5% 1/10W
JR125	1-216-295-91	SHORT	0	R061	1-216-025-91	RES, CHIP	100 5% 1/10W
JR132	1-216-295-91	SHORT	0	R062	1-216-182-00	RES, CHIP	220 5% 1/8W
R001	1-216-025-91	RES, CHIP	100 5% 1/10W	R063	1-216-089-91	RES, CHIP	47K 5% 1/10W
R002	1-216-025-91	RES, CHIP	100 5% 1/10W	R064	1-216-089-91	RES, CHIP	47K 5% 1/10W
R003	1-216-065-91	RES, CHIP	4.7K 5% 1/10W	R065	1-216-025-91	RES, CHIP	100 5% 1/10W
R004	1-216-065-91	RES, CHIP	4.7K 5% 1/10W	R066	1-216-057-00	RES, CHIP	2.2K 5% 1/10W
R005	1-216-214-00	RES, CHIP	4.7K 5% 1/8W	R067	1-216-065-91	RES, CHIP	4.7K 5% 1/10W
R009	1-216-025-91	RES, CHIP	100 5% 1/10W	R069	1-216-041-00	RES, CHIP	470 5% 1/10W
R010	1-216-025-91	RES, CHIP	100 5% 1/10W	R071	1-216-200-11	RES, CHIP	1.2K 5% 1/8W
R011	1-216-025-91	RES, CHIP	100 5% 1/10W	R075	1-216-214-00	RES, CHIP	4.7K 5% 1/8W
R012	1-247-807-31	CARBON	100 5% 1/4W	R077	1-216-082-00	RES, CHIP	24K 5% 1/10W
R013	1-216-065-91	RES, CHIP	4.7K 5% 1/10W	R082	1-216-017-91	RES, CHIP	47 5% 1/10W
R014	1-216-057-00	RES, CHIP	2.2K 5% 1/10W	R083	1-216-174-00	RES, CHIP	100 5% 1/8W
R015	1-216-045-00	RES, CHIP	680 5% 1/10W	R084	1-216-166-00	RES, CHIP	47 5% 1/8W
R016	1-216-055-00	RES, CHIP	1.8K 5% 1/10W	R085	1-216-174-00	RES, CHIP	100 5% 1/8W
R017	1-249-429-11	CARBON	10K 5% 1/4W	R086	1-216-166-00	RES, CHIP	47 5% 1/8W
R018	1-216-065-91	RES, CHIP	4.7K 5% 1/10W	R087	1-216-025-91	RES, CHIP	100 5% 1/10W
				R088	1-216-065-91	RES, CHIP	4.7K 5% 1/10W
				R089	1-216-081-00	RES, CHIP	22K 5% 1/10W

REF. NO.	PART.NO	DESCRIPTION	REMARK	REF. NO.	PART.NO	DESCRIPTION	REMARK
R090	1-216-206-00	RES, CHIP	2.2K 5% 1/8W	R314	1-216-025-91	RES, CHIP	100 5% 1/10W
R091	1-216-081-00	RES, CHIP	22K 5% 1/10W	R315	1-216-075-00	RES, CHIP	12K 5% 1/10W
R092	1-216-073-00	RES, CHIP	10K 5% 1/10W	R316	1-216-025-91	RES, CHIP	100 5% 1/10W
R094	1-216-025-91	RES, CHIP	100 5% 1/10W	R317	1-216-097-91	RES, CHIP	100K 5% 1/10W
R095	1-216-025-91	RES, CHIP	100 5% 1/10W	R318	1-216-025-91	RES, CHIP	100 5% 1/10W
R096	1-247-807-31	CARBON	100 5% 1/4W	R319	1-216-025-91	RES, CHIP	100 5% 1/10W
R097	1-247-807-31	CARBON	100 5% 1/4W	R320	1-216-025-91	RES, CHIP	100 5% 1/10W
R098	1-216-097-91	RES, CHIP	100K 5% 1/10W	R321	1-216-025-91	RES, CHIP	100 5% 1/10W
R099	1-216-246-00	RES, CHIP	100K 5% 1/8W	R322	1-216-047-91	RES, CHIP	820 5% 1/10W
R101	1-216-049-91	RES, CHIP	1K 5% 1/10W	R323	1-216-025-91	RES, CHIP	100 5% 1/10W
R103	1-216-041-00	RES, CHIP	470 5% 1/10W	R324	1-412-002-31	INDUCTOR CHIP 4.7UH	
R105	1-216-069-00	RES, CHIP	6.8K 5% 1/10W	R325	1-412-002-31	INDUCTOR CHIP 4.7UH	
R106	1-215-900-11	METAL OXIDE	22K 5% 2W F	R327	1-216-295-91	SHORT	0
R120	1-216-037-00	RES, CHIP	330 5% 1/10W	R328	1-216-049-91	RES, CHIP	1K 5% 1/10W
R121	1-216-025-91	RES, CHIP	100 5% 1/10W	R329	1-216-031-00	RES, CHIP	180 5% 1/10W
R122	1-216-025-91	RES, CHIP	100 5% 1/10W	R330	1-216-089-91	RES, CHIP	47K 5% 1/10W
R125	1-249-417-11	CARBON	1K 5% 1/4W	R331	1-216-057-00	RES, CHIP	2.2K 5% 1/10W
R126	1-216-081-00	RES, CHIP	22K 5% 1/10W	R332	1-216-206-00	RES, CHIP	2.2K 5% 1/8W
R130	1-216-085-91	RES, CHIP	33K 5% 1/10W	R333	1-216-206-00	RES, CHIP	2.2K 5% 1/8W
R134	1-216-075-00	RES, CHIP	12K 5% 1/10W	R334	1-216-025-91	RES, CHIP	100 5% 1/10W
R144	1-216-222-00	RES, CHIP	10K 5% 1/8W	R335	1-216-025-91	RES, CHIP	100 5% 1/10W
R145	1-216-212-00	RES, CHIP	3.9K 5% 1/8W	R336	1-216-077-00	RES, CHIP	15K 5% 1/10W
R146	1-216-105-91	RES, CHIP	220K 5% 1/10W	R338	1-216-049-91	RES, CHIP	1K 5% 1/10W
R151	1-216-049-91	RES, CHIP	1K 5% 1/10W	R339	1-216-081-00	RES, CHIP	22K 5% 1/10W
R153	1-216-180-00	RES, CHIP	180 5% 1/8W	R340	1-535-143-11	LEAD, JUMPER (10. MM)	
R154	1-216-238-91	RES, CHIP	47K 5% 1/8W	R341	1-535-143-11	LEAD, JUMPER (10. MM)	
R155	1-216-079-00	RES, CHIP	18K 5% 1/10W	R342	1-216-103-00	RES, CHIP	180K 5% 1/10W
R202	1-216-113-91	RES, CHIP	470K 5% 1/10W	R401	1-216-113-00	RES, CHIP	470K 5% 1/10W
R203	1-216-081-91	RES, CHIP	22K 5% 1/10W	R402	1-216-295-91	SHORT	0
R204	1-247-863-91	CARBON	22K 5% 1/4W	R403	1-216-041-00	RES, CHIP	470 5% 1/10W
R206	1-216-085-00	RES, CHIP	33K 5% 1/10W	R404	1-216-113-00	RES, CHIP	470K 5% 1/10W
R208	1-216-055-00	RES, CHIP	1.8K 5% 1/10W	R406	1-216-113-00	RES, CHIP	470K 5% 1/10W
R209	1-216-055-00	RES, CHIP	1.8K 5% 1/10W	R407	1-216-295-91	SHORT	0
R211	1-215-873-00	METAL OXIDE	4.7K 5% 1W F	R408	1-216-022-00	RES, CHIP	75 5% 1/10W
R213	1-216-093-91	RES, CHIP	68K 5% 1/10W	R409	1-216-174-00	RES, CHIP	100 5% 1/8W
R301	1-216-025-91	RES, CHIP	100 5% 1/10W	R410	1-216-174-00	RES, CHIP	100 5% 1/8W
R302	1-216-081-00	RES, CHIP	22K 5% 1/10W	R411	1-216-022-00	RES, CHIP	75 5% 1/10W
R303	1-216-073-00	RES, CHIP	10K 5% 1/10W	R412	1-216-174-00	RES, CHIP	100 5% 1/8W
R304	1-216-065-91	RES, CHIP	4.7K 5% 1/10W	R413	1-216-295-91	SHORT	0
R305	1-412-002-31	INDUCTOR CHIP	4.7UH	R414	1-216-022-00	RES, CHIP	75 5% 1/10W
R306	1-216-057-00	RES, CHIP	2.2K 5% 1/10W	R415	1-216-022-00	RES, CHIP	75 5% 1/10W
R307	1-216-041-00	RES, CHIP	470 5% 1/10W	R417	1-249-403-11	CARBON	68 5% 1/4W
R308	1-216-049-91	RES, CHIP	1K 5% 1/10W	R418	1-249-413-11	CARBON	470 5% 1/4W
R309	1-216-675-11	METAL CHIP	10K 0.50% 1/10W	R419	1-216-022-00	RES, CHIP	75 5% 1/10W
R310	1-216-022-00	RES, CHIP	75 5% 1/10W	R420	1-216-041-00	RES, CHIP	470 5% 1/10W
R312	1-216-061-00	RES, CHIP	3.3K 5% 1/10W	R421	1-216-113-00	RES, CHIP	470K 5% 1/10W
R313	1-216-025-91	RES, CHIP	100 5% 1/10W	R425	1-216-073-00	RES, CHIP	10K 5% 1/10W

**A**

The components identified by shading and marked **△** are critical for safety  
 Replace only with the part number specified.

REF. NO.	PART.NO	DESCRIPTION	REMARK	REF. NO.	PART.NO	DESCRIPTION	REMARK
R427	1-216-113-00	RES,CHIP	470K 5% 1/10W	R540	1-215-861-00	METAL OXIDE	47 5% 1W F
R429	1-216-041-00	RES,CHIP	470 5% 1/10W	R542	1-216-089-91	RES,CHIP	47K 5% 1/10W
R430	1-216-113-00	RES,CHIP	470K 5% 1/10W	R543	1-216-089-91	RES,CHIP	47K 5% 1/10W
R432	1-216-113-00	RES,CHIP	470K 5% 1/10W	R546	1-249-401-11	CARBON	47 5% 1/4W F
R435	1-216-022-00	RES,CHIP	75 5% 1/10W	R547	1-535-303-00	LEAD, JUMPER (5.0MM)	
R437	1-216-022-00	RES,CHIP	75 5% 1/10W	R549	1-216-363-00	METAL OXIDE	0.33 5% 2W F
R439	1-216-041-00	RES,CHIP	470 5% 1/10W	R551	1-215-873-00	METAL OXIDE	4.7K 5% 1W F
R440	1-216-113-00	RES,CHIP	470K 5% 1/10W	R552	1-216-061-00	RES,CHIP	3.3K 5% 1/10W
R442	1-216-073-00	RES,CHIP	10K 5% 1/10W	R553	1-249-381-11	CARBON	1 5% 1/4W F
R445	1-216-171-00	RES,CHIP	75 5% 1/8W	R555	1-216-059-00	RES,CHIP	2.7K 5% 1/10W
R450	1-216-041-00	RES,CHIP	470 5% 1/10W	R571	1-249-417-11	CARBON	1K 5% 1/4W F
R454	1-216-041-00	RES,CHIP	470 5% 1/10W	R572	1-216-369-00	METAL OXIDE	1 5% 2W F
R457	1-216-174-00	RES,CHIP	100 5% 1/8W	R574	1-216-065-91	RES,CHIP	4.7K 5% 1/10W
R459	1-247-807-31	CARBON	100 5% 1/4W	R575	1-216-097-91	RES,CHIP	100K 5% 1/10W
R460	1-249-403-11	CARBON	68 5% 1/4W	R581	1-216-089-91	RES,CHIP	47K 5% 1/10W
R461	1-216-033-00	RES,CHIP	220 5% 1/10W	R582	1-216-089-91	RES,CHIP	47K 5% 1/10W
R501	1-216-081-00	RES,CHIP	22K 5% 1/10W	R583	1-216-081-00	RES,CHIP	22K 5% 1/10W
R502	1-216-097-91	RES,CHIP	100K 5% 1/10W	R589	1-216-097-91	RES,CHIP	100K 5% 1/10W
R503	1-215-888-00	METAL OXIDE	220 5% 2W F	R590	1-216-230-00	RES,CHIP	22K 5% 1/8W
R504	1-249-385-11	CARBON	2.2 5% 1/4W F	R591	1-215-892-11	METAL OXIDE	1K 5% 2W F
R505	1-216-667-91	METAL CHIP	4.7K 0.50% 1/10W	R593	1-249-439-11	CARBON	68K 5% 1/4W
R506	1-216-663-11	METAL CHIP	3.3K 0.50% 1/10W	R594	1-216-057-00	RES,CHIP	2.2K 5% 1/10W
R507	1-216-349-00	METAL OXIDE	1 5% 1W F	R595	1-249-377-11	CARBON	0.47 5% 1/4W F
R508	1-216-667-91	METAL CHIP	4.7K 0.50% 1/10W	R602	△ 1-202-961-11	CEMENTED	1.8 5% 10W
R509	1-216-663-11	METAL CHIP	3.3K 0.50% 1/10W	R603	1-202-933-61	FUSIBLE	0.1 10% 1/2W F
R510	1-216-081-00	RES,CHIP	22K 5% 1/10W	R604	1-249-421-11	CARBON	2.2K 5% 1/4W
R511	1-215-869-11	METAL OXIDE	1K 5% 1W F	R607	△ 1-202-961-11	CEMENTED	1.8 5% 10W
R512	1-249-382-11	CARBON	1.2 5% 1/4W F	R608	1-216-488-11	METAL OXIDE	18K 5% 3W F
R513	1-216-097-91	RES,CHIP	100K 5% 1/10W	R611	1-249-415-11	CARBON	680 5% 1/4W
R514	1-249-377-11	CARBON	0.47 5% 1/4W F	R616	1-216-393-00	METAL OXIDE	2.2 5% 3W F
R515	1-249-377-11	CARBON	0.47 5% 1/4W F	R617	1-249-405-11	CARBON	100 5% 1/4W F
R516	1-249-493-11	CARBON	56K 5% 1/2W	R619	1-216-214-00	RES,CHIP	4.7K 5% 1/8W
R518	1-216-059-00	RES,CHIP	2.7K 5% 1/10W	R620	1-216-055-00	RES,CHIP	1.8K 5% 1/10W
R520	1-215-884-11	METAL OXIDE	47 5% 2W F	R622	1-249-401-11	CARBON	47 5% 1/4W
R522	1-216-097-91	RES,CHIP	100K 5% 1/10W	R628	1-247-791-91	CARBON	22 5% 1/4W
R523	1-216-121-91	RES,CHIP	1M 5% 1/10W	R632	△ 1-240-030-91	METAL	4.7M 5% 1/2W
R524	1-216-083-00	RES,CHIP	27K 5% 1/10W	R634	△ 1-240-030-91	METAL	4.7M 5% 1/2W
R525	1-216-057-00	RES,CHIP	2.2K 5% 1/10W	R651	△ 1-220-926-11	FUSIBLE	0.47 10% 1/2W F
R526	1-216-089-91	RES,CHIP	47K 5% 1/10W	R652	1-216-393-00	METAL OXIDE	2.2 5% 3W F
R527	1-216-077-00	RES,CHIP	15K 5% 1/10W	R653	1-216-393-00	METAL OXIDE	2.2 5% 3W F
R528	1-216-097-91	RES,CHIP	100K 5% 1/10W	R654	1-249-389-11	CARBON	4.7 5% 1/4W F
R529	1-216-073-00	RES,CHIP	10K 5% 1/10W	R658	1-215-929-11	METAL OXIDE	100K 5% 3W F
R530	1-216-085-00	RES,CHIP	33K 5% 1/10W	R659	1-216-383-11	METAL OXIDE	0.33 5% 3W F
R531	1-216-057-00	RES,CHIP	2.2K 5% 1/10W	R660	1-216-383-11	METAL OXIDE	0.33 5% 3W F
R532	1-216-065-91	RES,CHIP	4.7K 5% 1/10W	R661	1-247-843-11	CARBON	3.3K 5% 1/4W
R533	1-216-073-00	RES,CHIP	10K 5% 1/10W	R662	1-215-929-11	METAL OXIDE	100K 5% 3W F
R539	1-216-049-91	RES,CHIP	1K 5% 1/10W	R665	1-215-902-51	METAL OXIDE	47K 5% 2W F

The components identified by shading and marked  $\Delta$  are critical for safety. Replace only with the part number specified.

**A**

REF. NO.	PART.NO	DESCRIPTION	REMARK	REF. NO.	PART.NO	DESCRIPTION	REMARK
R666	1-535-143-71	LEAD, JUMPER (7.5MM)		C606	1-125-318-00	ELECT(BLOCK) 220MF	20% 400V
R667	1-215-900-51	METAL OXIDE 22K 5% 2W F		C638	1-107-670-11	ELECT 10MF	20% 400V
< RELAY >				< FILTER >			
RY601	E 1-755-266-11	RELAY, AC POWER		SWF101	1-767-874-11	FILTER, SURFACE WAVE	
< SWITCH >				< IC >			
SW532	1-572-707-11	SWITCH, LEVER		IC101	8-759-466-49	IC TDA9817/V1	
< TRANSFORMER >				< COIL >			
T511	E 1-453-308-11	TRANSFORMER ASSY, FLYBACK NX-4521//U2B4		L105	1-408-603-31	INDUCTOR 10UH	
T531	1-437-195-11	TRANSFORMER, HORIZONTAL DRIVE		< TRANSISTOR >			
T532	1-426-981-11	TRANSFORMER, FERRITE (PMT)		Q108	8-729-120-08	TRANSISTOR 2SC1623-L5L6	(KV-25FX20A/25FX20D/25FX20E)
T601	E 1-427-962-11	TRANSFORMER, LINE FILTER			8-729-901-81	TRANSISTOR 2SC2412K	(KV-29FX20A/29FX20D/29FX20E)
T602	1-431-732-21	TRANSFORMER, CONVERTER (SRT)		Q160	8-729-031-81	TRANSISTOR 2PD601AR	(KV-29FX20A/29FX20D/29FX20E)
T603	E 1-433-933-11	TRANSFORMER, CONVERTER (SRT)		< RESISTOR >			
< CRYSTAL >				JR113	1-216-295-91	SHORT 0	
X001	1-578-774-11	VIBRATOR, CRYSTAL		R114	1-216-295-91	SHORT 0	
X302	1-567-505-11	OSCILLATOR, CRYSTAL		R133	1-216-295-91	SHORT 0	
X303	1-567-504-11	OSCILLATOR, CRYSTAL		R137	1-216-035-00	RES,CHIP 270 5% 1/10W	
< CAPACITOR >				R138	1-216-097-91	RES,CHIP 100K 5% 1/10W	
C111	1-216-296-91	SHORT 0		R139	1-216-093-91	RES,CHIP 68K 5% 1/10W	
C123	1-102-108-91	CERAMIC CHIP 150PF 10% 50V		R140	1-216-035-00	RES,CHIP 270 5% 1/10W	
C124	1-104-664-11	ELECT 47MF 20% 25V		R141	1-216-043-91	RES,CHIP 560 5% 1/10W	
C125	1-101-880-91	CERAMIC CHIP 47PF 5% 50V		R143	1-216-031-91	RES,CHIP 180 5% 1/10W	(KV-25FX20A/25FX20D/25FX20E)
C132	1-102-525-91	CERAMIC CHIP 68PF 5% 50V			1-247-809-91	RES,CHIP 120 5% 1/10W	(KV-29FX20A/29FX20D/29FX20E)
C536	1-117-813-11	FILM 0.75MF 5% 250V		R159	1-247-843-91	CARBON 3.3K 5% 1/4W	
		(KV-25FX20A/25FX20D/25FX20E)		R160	1-216-049-91	RES,CHIP 1K 5% 1/10W	(KV-29FX20A/29FX20D/29FX20E)
	1-115-521-11	FILM 0.82MF 5% 250V		R161	1-216-021-91	RES,CHIP 68 5% 1/10W	(KV-29FX20A/29FX20D/29FX20E)
		(KV-29FX20A/29FX20D/29FX20E)		R326	1-216-121-91	RES,CHIP 1M 5% 1/10W	(KV-25FX20A/25FX20D/25FX20E)
C546	1-130-895-00	FILM 0.056MF 5% 400V			1-216-113-00	RES,CHIP 470K 5% 1/10W	(KV-29FX20A/29FX20D/29FX20E)
		(KV-25FX20A/25FX20D/25FX20E)		R517	1-247-859-91	CARBON 15K 5% 1/4W	(KV-25FX20A/25FX20D/25FX20E)
	1-130-118-00	FILM 0.051MF 5% 400V			1-249-428-11	CARBON 8.2K 5% 1/4W	(KV-29FX20A/29FX20D/29FX20E)
		(KV-29FX20A/29FX20D/29FX20E)					
C553	1-137-417-11	MYLAR 0.0047MF 10% 200V					
C555	1-128-935-11	CERAMIC CHIP 19000PF 3% 1200V					
		(KV-29FX20A/29FX20D/29FX20E)					
C572	1-128-526-11	ELECT 100MF 20% 16V					
C582	1-163-267-91	CERAMIC CHIP 470PF 5% 50V					
		(KV-25FX20A/25FX20D/25FX20E)					
	1-163-259-91	CERAMIC CHIP 220PF 5% 50V					
		(KV-29FX20A/29FX20D/29FX20E)					

**A Board Variant Parts**  
**KV-25FX20A/25FX20D/25FX20E/**  
**KV-29FX20A/29FX20D/29FX20E**



The components identified by shading and marked **△** are critical for safety  
Replace only with the part number specified.

REF. NO.	PART.NO	DESCRIPTION	REMARK	REF. NO.	PART.NO	DESCRIPTION	REMARK
R505	1-126-667-11	METAL CHIP	4.7K 0.50% 1/10W (KV-25FX20A/25FX20D/25FX20E)	C111	1-163-059-00	CERAMIC CHIP 0.01MF	50V
R508	1-126-667-11	METAL CHIP	4.7K 0.50% 1/10W (KV-25FX20/25FX20D/25FX20E)	C121	1-163-031-11	CERAMIC CHIP 0.01MF	50V
R521	1-216-117-00	RES,CHIP	680K 5% 1/10W (KV-25FX20A/25FX20D/25FX20E)	C133	1-162-638-11	CERAMIC CHIP 1MF	16V
	1-216-121-91	RES,CHIP	1M 5% 1/10W (KV-29FX20A/29FX20D/29FX20E)	C140	1-104-664-11	ELECT 47MF	20% 16V
R534	1-216-113-00	RES,CHIP	470K 5% 1/10W (KV-25FX20A/25FX20D/25FX20E)	C536	1-117-813-11	FILM 0.75MF	5% 250V (KV-25FX20B)
	1-216-105-91	RES,CHIP	220K 5% 1/10W (KV-29FX20A/29FX20D/29FX20E)		1-115-521-11	FILM 0.82MF	5% 250V (KV-29FX20B)
R535	1-216-109-00	RES,CHIP	330K 5% 1/10W (KV-25FX20A/25FX20D/25FX20E)	C546	1-130-895-00	FILM 0.056MF	5% 400V (KV-25FX20B)
	1-216-101-00	RES,CHIP	150K 5% 1/10W (KV-29FX20A/29FX20D/29FX20E)		1-130-118-00	FILM 0.051MF	5% 400V (KV-29FX20B)
R541	1-216-093-91	RES,CHIP	68K 5% 1/10W (KV-25FX20A/25FX20D/25FX20E)	C553	1-137-417-11	MYLAR 0.0047MF	10% 200V
	1-216-097-91	RES,CHIP	100K 5% 1/10W (KV-29FX20A/29FX20D/29FX20E)	C555	1-128-935-11	CERAMIC CHIP 19000PF	3% 1200V (KV-29FX20B)
R548	1-212-849-61	FUSIBLE	4.7 5% 1/4W (KV-25FX20A/25FX20D/25FX20E)	C572	1-128-526-11	ELECT 100MF	20% 16V
	1-202-973-61	FUSIBLE	3.3 5% 1/10W (KV-29FX20A/29FX20D/29FX20E)	C582	1-163-133-00	CERAMIC CHIP 470PF	5% 50V (KV-25FX20B)
R573	1-216-109-91	RES,CHIP	330K 5% 1/10W (KV-25FX20A/25FX20D/25FX20E)		1-163-259-91	CERAMIC CHIP 220PF	5% 50V (KV-29FX20B)
	1-216-097-91	RES,CHIP	100K 5% 1/10W (KV-29FX20A/29FX20D/29FX20E)	C606	1-125-318-00	ELECT(BLOCK) 220MF	20% 400V
R588	1-216-061-00	RES,CHIP	3.3K 5% 1/10W (KV-25FX20A/25FX20D/25FX20E)	C638	1-107-670-11	ELECT 10MF	20% 400V
	1-216-065-91	RES,CHIP	4.7K 5% 1/10W (KV-29FX20A/29FX20D/29FX20E)	< FILTER >			
< TRANSFORMER >				CF105	1-760-154-11	TRAP, CERAMIC	
T533	1-433-905-11	TRANSFORMER, HORIZONTAL LINEAR	(KV-25FX20A/25FX20D/25FX20E)	SWF101	1-579-273-11	FILTER, SURFACE WAVE	
	1-433-906-11	TRANSFORMER, HORIZONTAL LINEAR	(KV-29FX20A/29FX20D/29FX20E)	SWF103	1-767-083-11	FILTER, SURFACE WAVE	
< THERMISTOR >				< DIODE >			
THP601	E 1-810-961-11	THERMISTOR, POSITIVE		D102	8-719-050-59	DIODE BA592-GEG	
< TUNER >				D104	8-719-914-43	DIODE DAN202K	
TU101	8-598-432-00	TUNER (BTP-AC411)		< IC >			
<b>A Board Variant Parts KV-25FX20B/29FX20B</b>				IC101	8-759-466-47	IC TDA9818/V1	
< CAPACITOR >				< COIL >			
C100	1-163-038-91	CERAMIC CHIP 0.1MF	25V	L108	1-410-985-42	INDUCTOR CHIP 0.22UH	
				L109	1-410-789-11	INDUCTOR 0.47UH	
				L117	1-412-002-42	INDUCTOR CHIP 4.7UH	
				< TRANSISTOR >			
				O102	8-729-920-72	TRANSISTOR 2SA1037K-T-146-QR	
				O104	1-801-806-11	TRANSISTOR DTC144EKA-T146	
				O107	8-729-022-54	TRANSISTOR 2SC3779C, D-AA	
				O109	1-801-806-11	TRANSISTOR DTC144EKA-T146	
				O110	1-801-806-11	TRANSISTOR DTC144EKA-T146	

The components identified by shading and marked **△** are critical for safety  
 Replace only with the part number specified.

**A**

REF. NO.	PART.NO	DESCRIPTION	REMARK	REF. NO.	PART.NO	DESCRIPTION	REMARK	
< RESISTOR >				< VARIABLE RESISTOR >				
R109	1-216-061-00	RES, CHIP	3.3K 5% 1/10W	RV101	1-241-765-11	RES, ADJ, CARBON 22K		
R110	1-216-200-11	RES, CHIP	1.2K 5% 1/8W	< TRANSFORMER >				
R111	1-216-053-00	RES, CHIP	1.5K 5% 1/10W	T533	1-433-905-11	TRANSFORMER, HORIZONTAL LINEAR (KV-25FX20B)		
R112	1-216-053-00	RES, CHIP	1.5K 5% 1/10W		1-433-906-11	TRANSFORMER, HORIZONTAL LINEAR (KV-29FX20B)		
R113	1-216-027-00	RES, CHIP	120 5% 1/10W	< THERMISTOR >				
R114	1-216-190-00	RES, CHIP	470 5% 1/8W	THP601	△ 1-810-961-11	THERMISTOR, POSITIVE		
R123	1-216-037-91	RES, CHIP	330 5% 1/10W	< TUNER >				
R127	1-216-031-00	RES, CHIP	180 5% 1/10W	TU101	1-693-418-11	TUNER (TELE9-001A)		
R128	1-216-065-91	RES, CHIP	4.7K 5% 1/10W	<b>A Board Variant Parts KV-25FX20K/29FX20K</b>				
R129	1-216-063-91	RES, CHIP	3.9K 5% 1/10W	< CAPACITOR >				
R137	1-216-057-00	RES, CHIP	2.2K 5% 1/10W	C111	1-216-296-91	SHORT 0		
R138	1-216-087-91	RES, CHIP	39K 5% 1/10W	C123	1-102-106-91	CERAMIC CHIP 100PF	10% 50V	
R139	1-216-075-00	RES, CHIP	12K 5% 1/10W	C124	1-104-664-11	ELECT 47MF	20% 25V	
R141	1-216-295-91	SHORT	0	C125	1-102-106-91	CERAMIC CHIP 100PF	10% 50V	
R142	1-216-043-91	RES, CHIP	560 5% 1/10W	C536	1-117-813-11	FILM 0.75MF	5% 250V	
R147	1-216-017-91	RES, CHIP	47 5% 1/10W		1-115-521-11	FILM 0.82MF	5% 250V	
R148	1-216-174-00	RES, CHIP	100 5% 1/8W				(KV-25FX20K)	
R149	1-216-049-91	RES, CHIP	1K 5% 1/10W	C546	1-130-895-00	FILM 0.056MF	5% 400V	
R152	1-216-025-91	RES, CHIP	100 5% 1/10W		1-130-118-00	FILM 0.051MF	5% 400V	
R156	1-216-065-91	RES, CHIP	4.7K 5% 1/10W				(KV-29FX20K)	
R157	1-216-065-91	RES, CHIP	4.7K 5% 1/10W	C553	1-137-417-11	MYLAR 0.0047MF	10% 200V	
R158	1-216-025-91	RES, CHIP	100 5% 1/10W	C555	1-128-935-11	CERAMIC CHIP 19000PF	3% 1200V	
R159	1-247-835-91	CARBON	1.5K 5% 1/10W (KV-25FX20B)		C572	1-128-526-11	ELECT 100MF	20% 16V
	1-249-419-11	CARBON	1.5K 5% 1/4W (KV-29FX20B)	C582	1-163-267-91	CERAMIC CHIP 470PF	5% 50V	
R160	1-216-295-91	SHORT	0 (KV-29FX20B)		1-163-259-91	CERAMIC CHIP 220PF	5% 50V	
R161	1-216-295-91	SHORT	0 (KV-29FX20B)				(KV-29FX20K)	
R326	1-216-121-91	RES, CHIP	1M 5% 1/10W (KV-25FX20B)	C606	1-125-318-00	ELECT(BLOCK) 220MF	20% 400V	
	1-216-113-00	RES, CHIP	470K 5% 1/10W (KV-29FX20B)	C638	1-107-670-11	ELECT 10MF	20% 400V	
R505	1-216-667-11	METAL CHIP	4.7K 0.50% 1/10W (KV-25FX20B)	< FILTER >				
R508	1-216-667-11	METAL CHIP	4.7K 0.50% 1/10W (KV-25FX20B)	SWF101	1-579-273-11	FILTER, SURFACE WAVE		
R517	1-247-859-91	CARBON	15K 5% 1/4W (KV-25FX20B)	< IC >				
	1-249-428-11	CARBON	8.2K 5% 1/4W (KV-29FX20B)	IC101	8-759-466-49	IC TDA9817/V1		
R521	1-216-117-00	RES, CHIP	680K 5% 1/10W (KV-25FX20B)					
	1-216-121-91	RES, CHIP	1M 5% 1/10W (KV-29FX20B)					
R534	1-216-113-00	RES, CHIP	470K 5% 1/10W (KV-25FX20B)					
	1-216-105-91	RES, CHIP	220K 5% 1/10W (KV-29FX20B)					
R535	1-216-109-00	RES, CHIP	330K 5% 1/10W (KV-25FX20B)					
	1-216-101-91	RES, CHIP	150K 5% 1/10W (KV-29FX20B)					
R541	1-216-093-91	RES, CHIP	68K 5% 1/10W (KV-25FX20B)					
	1-216-097-91	RES, CHIP	100K 5% 1/10W (KV-29FX20B)					
R548	1-202-973-61	FUSIBLE	3.3 5% 1/10W (KV-29FX20B)					
R573	1-216-109-91	RES, CHIP	330K 5% 1/10W (KV-25FX20B)					
	1-216-097-91	RES, CHIP	100K 5% 1/10W (KV-29FX20B)					
R588	1-216-061-00	RES, CHIP	3.3K 5% 1/10W (KV-25FX20B)					
	1-216-065-11	RES, CHIP	4.7K 5% 1/10W (KV-29FX20B)					



The components identified by shading and marked **△** are critical for safety  
Replace only with the part number specified.

REF. NO.	PART.NO	DESCRIPTION	REMARK
< COIL >			
L105	1-408-603-31	INDUCTOR	10UH
< TRANSISTOR >			
Q108	8-729-120-08	TRANSISTOR 2SC1623-L5L6	(KV-25FX20K)
	8-729-901-81	TRANSISTOR 2SC2412K	(KV-29FX20K)
Q160	8-729-031-00	TRANSISTOR 2PD601AR	(KV-29FX20K)
< RESISTOR >			
JR113	1-216-295-91	SHORT	0
R114	1-216-295-91	SHORT	0
R133	1-216-295-91	SHORT	0
R137	1-216-035-00	RES,CHIP	270 5% 1/10W
R138	1-216-087-91	RES,CHIP	100K 5% 1/10W
R139	1-216-093-91	RES,CHIP	68K 5% 1/10W
R140	1-216-035-00	RES,CHIP	270 5% 1/10W
R141	1-216-043-91	RES,CHIP	560 5% 1/10W
R143	1-247-815-91	RES,CHIP	220 5% 1/10W
R159	1-247-843-91	CARBON	3.3K 5% 1/4W
R160	1-216-049-91	RES,CHIP	1K 5% 1/10W (KV-29FX20K)
R161	1-216-021-91	RES,CHIP	68 5% 1/10W (KV-29FX20K)
R326	1-216-121-91	RES,CHIP	1M 5% 1/10W (KV-25FX20K)
	1-216-113-00	RES,CHIP	470K 5% 1/10W (KV-29FX20K)
R505	1-216-667-11	METAL CHIP	4.7K 0.50% 1/10W (KV-25FX20K)
R508	1-216-667-11	METAL CHIP	4.7K 0.50% 1/10W (KV-25FX20K)
R517	1-247-859-91	CARBON	15K 5% 1/4W (KV-25FX20K)
	1-249-428-11	CARBON	8.2K 5% 1/4W (KV-29FX20K)
R521	1-216-117-00	RES,CHIP	680K 5% 1/10W (KV-25FX20K)
	1-216-121-91	RES,CHIP	1M 5% 1/10W (KV-29FX20K)
R534	1-216-113-00	RES,CHIP	470K 5% 1/10W (KV-25FX20K)
	1-216-105-91	RES,CHIP	220K 5% 1/10W (KV-29FX20K)
R535	1-216-109-00	RES,CHIP	330K 5% 1/10W (KV-25FX20K)
	1-216-101-00	RES,CHIP	150K 5% 1/10W (KV-29FX20K)
R541	1-216-093-91	RES,CHIP	68K 5% 1/10W (KV-25FX20K)
	1-216-097-91	RES,CHIP	100K 5% 1/10W (KV-29FX20K)
R548	1-212-849-61	FUSIBLE	4.7 5% 1/4W (KV-25FX20K)
	1-202-973-61	FUSIBLE	3.3 5% 1/4W (KV-29FX20K)
R573	1-216-109-91	RES,CHIP	330K 5% 1/10W (KV-25FX20K)
	1-216-097-91	RES,CHIP	100K 5% 1/10W (KV-29FX20K)
R588	1-216-061-00	RES,CHIP	3.3K 5% 1/10W (KV-25FX20K)
	1-216-065-91	RES,CHIP	4.7K 5% 1/10W (KV-29FX20K)
< TRANSFORMER >			
T533	1-433-905-11	TRANSFORMER, HORIZONTAL LINEAR	(KV-25FX20K)
	1-433-906-11	TRANSFORMER, HORIZONTAL LINEAR	(KV-29FX20K)

REF. NO.	PART.NO	DESCRIPTION	REMARK
< THERMISTOR >			
THP601	1-810-961-11	THERMISTOR, POSITIVE	
< TUNER >			
TU101	8-598-432-00	TUNER (BTP-AC411)	
<b>A Board Variant Parts KV-25FX20R/29FX20R</b>			
< CAPACITOR >			
C111	1-216-296-91	SHORT	0
C123	1-102-106-91	CERAMIC CHIP	100PF 10% 50V
C124	1-104-664-11	ELECT	47MF 20% 25V
C125	1-102-106-91	CERAMIC CHIP	100PF 10% 50V
C132	1-163-113-00	CERAMIC CHIP	68PF 5% 50V (KV-29FX20R)
C536	1-117-813-11	FILM	0.75MF 5% 250V (KV-25FX20R)
	1-115-521-11	FILM	0.82MF 5% 250V (KV-29FX20R)
C546	1-130-895-00	FILM	0.056MF 5% 400V (KV-25FX20R)
	1-130-118-00	FILM	0.051MF 5% 400V (KV-29FX20R)
C553	1-137-417-11	MYLAR	0.0047MF 10% 200V
C555	1-128-935-11	CERAMIC CHIP	19000PF 3% 1200V (KV-29FX20R)
C572	1-128-526-11	ELECT	100MF 20% 16V
C582	1-163-267-91	CERAMIC CHIP	470PF 5% 50V (KV-25FX20R)
	1-163-259-91	CERAMIC CHIP	220PF 5% 50V (KV-29FX20R)
C606	1-117-751-11	ELECT(BLOCK)	220MF 20% 450V
C638	1-107-679-41	ELECT	10MF 20% 450V
< FILTER >			
SWF101	1-579-273-11	FILTER, SURFACE WAVE	
< IC >			
IC101	8-759-466-49	IC TDA9817/V1	
< COIL >			
L105	1-408-603-31	INDUCTOR	10UH

The components identified by shading and marked  $\Delta$  are critical for safety  
 Replace only with the part number specified.

A

REF. NO.	PART.NO	DESCRIPTION	REMARK	REF. NO.	PART.NO	DESCRIPTION	REMARK
< TRANSISTOR >				< TUNER >			
Q108	8-729-120-08	TRANSISTOR 2SC1623-L5L6	(KV-25FX20R)	TU101	8-598-432-00	TUNER (BTP-AC411)	
	8-725-901-81	TRANSISTOR 2SC2412K	(KV-29FX20R)	<b>A Board Variant Parts KV-29FX20U</b>			
Q160	8-729-031-00	TRANSISTOR 2PD601AR	(KV-29FX20R)	< CAPACITOR >			
< RESISTOR >				C111	1-216-296-91	SHORT	0
JR113	1-216-295-91	SHORT	0	C536	1-115-521-11	FILM	0.82MF 5% 250V
R114	1-216-295-91	SHORT	0	C546	1-130-118-00	FILM	0.051MF 5% 400V
R133	1-216-295-91	SHORT	0	C553	1-106-359-00	MYLAR	0.0047MF 10% 100V
R137	1-216-035-00	RES,CHIP	270 5% 1/10W	C555	1-128-935-11	CERAMIC CHIP	19000PF 3% 1200V
R138	1-216-087-91	RES,CHIP	100K 5% 1/10W	C572	1-104-665-11	ELECT	100MF 20% 10V
R139	1-216-093-91	RES,CHIP	68K 5% 1/10W	C582	1-163-259-91	CERAMIC CHIP	220PF 5% 50V
R140	1-216-035-00	RES,CHIP	270 5% 1/10W	C606	1-125-318-00	ELECT(BLOCK)	220MF 20% 400V
R141	1-216-043-91	RES,CHIP	560 5% 1/10W	C638	1-107-670-11	ELECT	10MF 20% 400V
R143	1-247-815-91	RES,CHIP	220 5% 1/10W	< FILTER >			
R159	1-247-843-91	CARBON	3.3K 5% 1/4W	SWF101	1-579-273-11	FILTER, SURFACE WAVE	
R160	1-216-049-91	RES,CHIP	1K 5% 1/10W (KV-29FX20R)	< IC >			
R161	1-216-021-91	RES,CHIP	68 5% 1/10W (KV-29FX20R)	IC101	8-759-466-49	IC TDA9817/V1	
R326	1-216-121-91	RES,CHIP	1M 5% 1/10W (KV-25FX20R)	< TRANSISTOR >			
	1-216-113-00	RES,CHIP	470K 5% 1/10W (KV-29FX20R)	Q160	8-729-031-00	TRANSISTOR 2PD601AR	
R505	1-216-667-11	METAL CHIP	4.7K 0.50% 1/10W (KV-25FX20R)	< RESISTORS >			
R508	1-216-667-11	METAL CHIP	4.7K 0.50% 1/10W (KV-25FX20R)	JR113	1-216-295-91	SHORT	0
R517	1-247-859-91	CARBON	15K 5% 1/4W (KV-25FX20R)	R114	1-216-295-91	SHORT	0
	1-249-428-11	CARBON	8.2K 5% 1/4W (KV-29FX20R)	R133	1-216-295-91	SHORT	0
R521	1-216-117-00	RES,CHIP	680K 5% 1/10W (KV-25FX20R)	R139	1-216-093-91	RES,CHIP	68K 5% 1/10W
	1-216-121-91	RES,CHIP	1M 5% 1/10W (KV-29FX20R)	R141	1-216-043-91	RES,CHIP	560 5% 1/10W
R534	1-216-113-00	RES,CHIP	470K 5% 1/10W (KV-25FX20R)	R143	1-216-031-00	RES,CHIP	180 5% 1/10W
	1-216-105-91	RES,CHIP	220K 5% 1/10W (KV-29FX20R)	R160	1-216-049-91	RES,CHIP	1K 5% 1/10W
R535	1-216-109-00	RES,CHIP	330K 5% 1/10W (KV-25FX20R)	R161	1-216-021-91	RES,CHIP	68 5% 1/10W
	1-216-101-00	RES,CHIP	150K 5% 1/10W (KV-29FX20R)	R326	1-216-113-00	RES,CHIP	470K 5% 1/10W
R541	1-216-093-91	RES,CHIP	68K 5% 1/10W (KV-25FX20R)	R517	1-249-428-11	CARBON	8.2K 5% 1/4W
	1-216-097-91	RES,CHIP	100K 5% 1/10W (KV-29FX20R)	R521	1-216-121-91	RES,CHIP	1M 5% 1/10W
R548	1-212-849-61	FUSIBLE	4.7 5% 1/4W (KV-25FX20R)	R534	1-216-105-91	RES,CHIP	220K 5% 1/10W
	1-202-973-61	FUSIBLE	3.3 5% 1/4W (KV-29FX20R)	R535	1-216-101-00	RES,CHIP	150K 5% 1/10W
R573	1-216-109-91	RES,CHIP	330K 5% 1/10W (KV-25FX20R)	R541	1-216-097-91	RES,CHIP	100K 5% 1/10W
	1-216-097-91	RES,CHIP	100K 5% 1/10W (KV-29FX20R)	R548	1-202-973-61	FUSIBLE	3.3 5% 1/4W
R588	1-216-061-00	RES,CHIP	3.3K 5% 1/10W (KV-25FX20R)	R573	1-216-097-91	RES,CHIP	100K 5% 1/10W
	1-216-065-91	RES,CHIP	4.7K 5% 1/10W (KV-29FX20R)	R588	1-216-065-91	RES,CHIP	4.7K 5% 1/10W
< TRANSFORMER >				< THERMISTOR >			
T533	1-433-905-11	TRANSFORMER, HORIZONTAL LINEAR	(KV-25FX20R)	THP601 $\Delta$ 1-810-961-11 THERMISTOR, POSITIVE			
	1-433-906-11	TRANSFORMER, HORIZONTAL LINEAR	(KV-29FX20R)				





The components identified by shading and marked  $\Delta$  are critical for safety. Replace only with the part number specified.

REF. NO.	PART. NO	DESCRIPTION	REMARK
		< TRANSFORMER >	
T533	1-433-906-11	TRANSFORMER, HORIZONTAL LINEAR	
		< THERMISTOR >	
THP601	1-808-059-31	THERMISTOR, POSITIVE	
		< TUNER >	
TU101	8-598-464-10	TUNER (BTP-AU611)	
<b>*A-1638-127-A C Board, Complete</b>			
		< CAPACITOR >	
C702	1-102-109-00	CERAMIC 180PF	10% 50V
C703	1-102-109-00	CERAMIC 180PF	10% 50V
C704	1-101-004-00	CERAMIC 0.01MF	50V
C705	1-101-004-00	CERAMIC 0.01MF	50V
C706	1-102-074-00	CERAMIC 0.001MF	10% 50V
C707	1-102-074-00	CERAMIC 0.001MF	10% 50V
C708	1-162-114-00	CERAMIC 0.0047MF	2KV
C709	1-102-074-00	CERAMIC 0.001MF	10% 50V
C710	1-136-189-00	FILM 0.1MF	10% 250V
C712	1-102-109-00	CERAMIC 180PF	10% 50V
C713	1-101-004-00	CERAMIC 0.01MF	50V
C714	1-104-665-11	ELECT 100MF	20% 16V
C717	1-102-114-00	CERAMIC 470PF	10% 50V
C718	1-102-114-00	CERAMIC 470PF	10% 50V
C719	1-102-114-00	CERAMIC 470PF	10% 50V
		< CONNECTOR >	
CN701	1-784-633-11	PIN, CONNECTOR 4P	
CN702	1-695-915-11	TAB (CONTACT)	
CN703	*1-564-509-11	PLUG, CONNECTOR 6P	
		< DIODE >	
D702	8-719-991-33	DIODE 1SS133T-77	
D703	8-719-991-33	DIODE 1SS133T-77	
D704	8-719-991-33	DIODE 1SS133T-77	
D705	8-719-991-33	DIODE 1SS133T-77	
D706	8-719-991-33	DIODE 1SS133T-77	
D707	8-719-991-33	DIODE 1SS133T-77	
D708	8-719-991-33	DIODE 1SS133T-77	
D709	8-719-991-33	DIODE 1SS133T-77	
D710	8-719-991-33	DIODE 1SS133T-77	
D711	8-719-991-33	DIODE 1SS133T-77	
D712	8-719-991-33	DIODE 1SS133T-77	
D714	8-719-991-33	DIODE 1SS133T-77	

REF. NO.	PART. NO	DESCRIPTION	REMARK
D715	8-719-991-33	DIODE 1SS133T-77	
D716	8-719-991-33	DIODE 1SS133T-77	
D717	8-719-991-33	DIODE 1SS133T-77	
D718	8-719-991-33	DIODE 1SS133T-77	
D719	8-719-991-33	DIODE 1SS133T-77	
D721	8-719-991-33	DIODE 1SS133T-77	
D722	8-719-991-33	DIODE 1SS133T-77	
		< CRT SOCKET >	
J701	1-251-595-11	SOCKET, CRT	
		< COIL >	
L703	1-412-529-11	INDUCTOR 22UH	
L704	1-414-183-41	INDUCTOR 10UH	
		< TRANSISTOR >	
0701	8-729-046-28	TRANSISTOR BF420-126	
0702	8-729-119-78	TRANSISTOR 2SC2785-HFE	
0703	8-729-046-28	TRANSISTOR BF420-126	
0704	8-729-200-17	TRANSISTOR 2SA1091-0	
0705	8-729-119-78	TRANSISTOR 2SC2785-HFE	
0706	8-729-046-28	TRANSISTOR BF420-126	
0707	8-729-200-17	TRANSISTOR 2SA1091-0	
0708	8-729-119-78	TRANSISTOR 2SC2785-HFE	
0709	8-729-046-28	TRANSISTOR BF420-126	
0710	8-729-200-17	TRANSISTOR 2SA1091-0	
0711	8-729-119-78	TRANSISTOR 2SC2785-HFE	
0712	8-729-046-28	TRANSISTOR BF420-126	
0713	8-729-046-28	TRANSISTOR BF420-126	
0714	8-729-026-39	TRANSISTOR 2SA933AS-OT	
0715	8-729-200-17	TRANSISTOR 2SA1091-0	
0716	8-729-200-17	TRANSISTOR 2SA1091-0	
0717	8-729-200-17	TRANSISTOR 2SA1091-0	
		< RESISTOR >	
R701	1-247-895-91	CARBON 470K 5%	1/4W
R702	1-216-464-11	METAL OXIDE 18K 5%	2W F
R703	1-249-405-11	CARBON 100 5%	1/4W F
R704	1-535-143-21	LEAD, JUMPER (12.5MM)	
R705	1-249-931-11	CARBON 2.2K 5%	1/4W F
R706	1-247-815-91	CARBON 220 5%	1/4W
R707	1-249-412-11	CARBON 390 5%	1/4W
R708	1-249-401-11	CARBON 47 5%	1/4W
R709	1-202-844-00	SOLID 330K 10%	1/2W
R710	1-247-895-91	CARBON 470K 5%	1/4W
R712	1-249-931-11	CARBON 2.2K 5%	1/4W F

REF. NO.	PART.NO	DESCRIPTION	REMARK	REF. NO.	PART.NO	DESCRIPTION	REMARK
R713	1-247-903-00	CARBON	1M 5% 1/4W	C1804	1-126-964-11	ELECT	10MF 20% 50V
R714	1-216-464-11	METAL OXIDE	18K 5% 2W F	C1805	1-137-366-11	FILM	0.0022MF 5% 50V
R715	1-249-405-11	CARBON	100 5% 1/4W F	C1844	1-129-716-00	FILM	0.015MF 5% 630V
R716	1-247-815-91	CARBON	220 5% 1/4W	C1845	1-129-725-00	FILM	0.082MF 5% 400V
R717	1-249-412-11	CARBON	390 5% 1/4W	C1848	1-136-347-11	FILM	0.0047MF 5% 630V
R718	1-202-814-11	SOLID	33K 10% 1/2W	C1901	1-163-251-11	CERAMIC CHIP	100PF 5% 50V
R719	1-249-401-11	CARBON	47 5% 1/4W	C1902	1-137-374-11	FILM	0.047MF 5% 50V
R721	1-249-405-11	CARBON	100 5% 1/4W F	C1903	1-126-964-11	ELECT	10MF 20% 50V
R722	1-202-848-00	SOLID	680K 10% 1/2W	C1904	1-137-366-11	FILM	0.0022MF 5% 50V
R724	1-260-131-11	CARBON	470K 5% 1/2W	C1905	1-137-374-11	FILM	0.047MF 5% 50V
R725	1-249-425-11	CARBON	4.7K 5% 1/4W	C1906	1-163-021-91	CERAMIC CHIP	0.01MF 10% 50V
R726	1-249-931-11	CARBON	2.2K 5% 1/4W F	C1911	1-109-954-11	ELECT	0.47MF 20% 160V
R727	1-247-815-91	CARBON	220 5% 1/4W	C1912	1-102-030-00	CERAMIC	330PF 10% 500V
R729	1-249-412-11	CARBON	390 5% 1/4W	C1913	1-129-992-00	FILM	0.0024MF 5% 630V
R730	1-249-401-11	CARBON	47 5% 1/4W	C1914	1-102-244-00	CERAMIC	220PF 10% 500V
R733	1-249-437-11	CARBON	47K 5% 1/4W	C1915	1-136-205-11	FILM	0.022MF 10% 250V
R734	1-247-807-31	CARBON	100 5% 1/4W	C1916	1-163-005-11	CERAMIC CHIP	470PF 10% 50V
R736	1-216-464-11	METAL OXIDE	18K 5% 2W F	C1917	1-102-228-00	CERAMIC	470PF 10% 500V
R741	1-202-549-00	SOLID	100 20% 1/2W	C1951	1-126-964-11	ELECT	10MF 20% 50V
R746	1-249-417-11	CARBON	1K 5% 1/4W	C1952	1-126-964-11	ELECT	10MF 20% 50V
R750	1-249-417-11	CARBON	1K 5% 1/4W	C1953	1-136-159-00	FILM	0.033MF 5% 50V
R751	1-249-417-11	CARBON	1K 5% 1/4W	C1954	1-163-021-91	CERAMIC CHIP	0.01MF 10% 50V
< VARIABLE RESISTOR >				C1957	1-126-964-11	ELECT	10MF 20% 50V
RV701	1-230-641-11	RES, ADJ, METAL GLAZE	2.2M	C1958	1-136-169-00	FILM	0.22MF 5% 50V
RV702	1-241-656-21	RES, ADJ, METAL FILM	110M	C1959	1-136-169-00	FILM	0.22MF 5% 50V
<b>*A-1674-141-A VM Board, Complete (KV-25FX20)</b>				< CONNECTOR >			
<b>*A-1674-140-A VM Board, Complete (KV-29FX20)</b>				CN1702	*1-564-507-11	PLUG, CONNECTOR	4P
<b>VM Board Common Parts</b>				CN1705	*1-564-511-11	PLUG, CONNECTOR	8P
< CAPACITOR >				CN1718	*1-770-723-11	CONNECTOR, BOARD TO BOARD	8P
C1701	1-104-665-11	ELECT	100MF 20% 16V	CN1801	*1-564-506-11	PLUG, CONNECTOR	3P
C1704	1-163-021-91	CERAMIC CHIP	0.01MF 10% 50V	CN1809	*1-508-784-00	PIN, CONNECTOR (5MM PITCH)	1P
C1705	1-163-131-00	CERAMIC CHIP	390PF 5% 50V	< DIODE >			
C1706	1-163-249-91	CERAMIC CHIP	68PF 0.5PF 50V	D1703	8-719-991-33	DIODE	1SS133T-77
C1707	1-126-964-11	ELECT	10MF 20% 50V	D1704	1-535-303-00	LEAD, JUMPER (5.0MM)	
C1708	1-163-021-91	CERAMIC CHIP	0.01MF 10% 50V	D1705	1-535-303-00	LEAD, JUMPER (5.0MM)	
C1709	1-126-964-11	ELECT	10MF 20% 50V	D1706	8-719-991-33	DIODE	1SS133T-77
C1710	1-107-927-11	ELECT	3.3MF 20% 100V	D1707	8-719-991-33	DIODE	1SS133T-77
C1711	1-107-927-11	ELECT	3.3MF 20% 100V	D1708	8-719-055-76	DIODE	IN4148
C1712	1-136-153-00	FILM	0.01MF 5% 50V	D1709	8-719-055-76	DIODE	IN4148
C1713	1-104-664-11	ELECT	47MF 20% 25V	D1710	8-719-982-03	DIODE	MTZJ-3.6A
C1715	1-136-165-00	FILM	0.1MF 5% 50V	D1711	8-719-982-03	DIODE	MTZJ-3.6A
C1716	1-107-932-11	ELECT	47MF 20% 100V	D1801	8-719-110-17	DIODE	RD10ESB2
C1717	1-104-664-11	ELECT	47MF 20% 25V	D1802	8-719-110-17	DIODE	RD10ESB2
C1803	1-163-037-11	CERAMIC CHIP	0.022MF 10% 50V	D1803	8-719-110-17	DIODE	RD10ESB2
				D1840	8-719-302-43	DIODE	EL1Z
				D1901	8-719-991-33	DIODE	1SS133T-77



REF.NO.	PART.NO	DESCRIPTION	REMARK	REF.NO.	PART.NO	DESCRIPTION	REMARK
D1902	8-719-991-33	DIODE 1SS133T-77		R1704	1-216-051-00	RES,CHIP 1.2K 5%	1/10W
D1903	8-719-991-33	DIODE 1SS133T-77		R1705	1-216-031-00	RES,CHIP 180 5%	1/10W
D1904	8-719-991-33	DIODE 1SS133T-77		R1706	1-216-031-00	RES,CHIP 180 5%	1/10W
D1905	8-719-110-41	DIODE RD15ESB2		R1707	1-216-043-91	RES,CHIP 560 5%	1/10W
D1906	8-719-970-87	DIODE ERA38-06		R1708	1-216-041-00	RES,CHIP 470 5%	1/10W
D1907	8-719-970-87	DIODE ERA38-06		R1709	1-216-025-91	RES,CHIP 100 5%	1/10W
D1908	8-719-300-33	DIODE RU-3AM		R1710	1-216-057-00	RES,CHIP 2.2K 5%	1/10W
D1909	8-719-991-33	DIODE 1SS133T-77		R1711	1-216-065-91	RES,CHIP 4.7K 5%	1/10W
	< IC >			R1712	1-216-041-00	RES,CHIP 470 5%	1/10W
IC1801	8-759-603-37	IC M5216P		R1713	1-216-065-91	RES,CHIP 4.7K 5%	1/10W
IC1901	8-759-450-95	IC LM393N		R1714	1-216-019-00	RES,CHIP 56 5%	1/10W
IC1902	8-759-008-70	IC LM358N		R1715	1-216-025-91	RES,CHIP 100 5%	1/10W
	< COIL >			R1716	1-216-031-00	RES,CHIP 180 5%	1/10W
L1701	1-414-183-41	INDUCTOR 10UH		R1717	1-216-051-00	RES,CHIP 1.2K 5%	1/10W
L1702	1-414-183-41	INDUCTOR 10UH		R1718	1-260-091-11	CARBON 220 5%	1/2W
L1704	1-414-185-41	INDUCTOR 22UH		R1719	1-216-061-00	RES,CHIP 3.3K 5%	1/10W
L1843	1-406-989-21	INDUCTOR 10MMH		R1720	1-216-246-00	RES,CHIP 100K 5%	1/8W
L1901	1-406-677-11	INDUCTOR 10MMH		R1721	1-216-061-00	RES,CHIP 3.3K 5%	1/10W
L1959	1-406-679-11	INDUCTOR 22MMH		R1722	1-216-049-91	RES,CHIP 1K 5%	1/10W
	< TRANSISTOR >			R1723	1-216-081-00	RES,CHIP 22K 5%	1/10W
Q1701	8-729-120-28	TRANSISTOR 2SC1623-L5L6		R1724	1-216-081-00	RES,CHIP 22K 5%	1/10W
Q1702	8-729-120-28	TRANSISTOR 2SC1623-L5L6		R1725	1-216-049-91	RES,CHIP 1K 5%	1/10W
Q1703	8-729-120-28	TRANSISTOR 2SC1623-L5L6		R1726	1-247-863-91	CARBON 22K 5%	1/4W
Q1704	8-729-120-28	TRANSISTOR 2SC1623-L5L6		R1727	1-216-025-91	RES,CHIP 100 5%	1/10W
Q1705	8-729-120-28	TRANSISTOR 2SC1623-L5L6		R1728	1-216-025-91	RES,CHIP 100 5%	1/10W
Q1706	8-729-119-78	TRANSISTOR 2SC2785-HFE		R1729	1-247-775-91	CARBON 4.7 5%	1/4W
Q1707	8-729-119-78	TRANSISTOR 2SC2785-HFE		R1730	1-247-775-91	CARBON 4.7 5%	1/4W
Q1708	8-729-026-39	TRANSISTOR 2SA933AS-QT		R1731	1-215-895-11	METAL OXIDE 3.3K 5%	2W F
Q1709	8-729-049-09	TRANSISTOR BC327-25		R1732	1-215-867-00	METAL OXIDE 470 5%	1W F
Q1710	8-729-049-10	TRANSISTOR BC337-25		R1805	1-216-073-00	RES,CHIP 10K 5%	1/10W
Q1711	8-729-049-30	TRANSISTOR BD830		R1806	1-216-117-00	RES,CHIP 680K 5%	1/10W
Q1712	8-729-049-29	TRANSISTOR BD829		R1807	1-216-073-00	RES,CHIP 10K 5%	1/10W
Q1840	8-729-119-76	TRANSISTOR 2SA1175-HFE		R1808	1-216-073-00	RES,CHIP 10K 5%	1/10W
Q1841	8-729-039-68	TRANSISTOR IRF620		R1809	1-216-073-00	RES,CHIP 10K 5%	1/10W
Q1901	8-729-120-28	TRANSISTOR 2SC1623-L5L6		R1810	1-216-073-00	RES,CHIP 10K 5%	1/10W
Q1902	8-729-120-28	TRANSISTOR 2SC1623-L5L6		R1842	1-216-025-91	RES,CHIP 100 5%	1/10W
Q1903	8-729-043-95	TRANSISTOR 2SC3840(3)		R1846	1-216-057-00	RES,CHIP 2.2K 5%	1/10W
Q1906	8-729-120-28	TRANSISTOR 2SC1623-L5L6		R1901	1-216-089-91	RES,CHIP 47K 5%	1/10W
Q1907	8-729-140-97	TRANSISTOR 2SB734-34		R1903	1-216-073-00	RES,CHIP 10K 5%	1/10W
	< RESISTOR >			R1904	1-216-073-00	RES,CHIP 10K 5%	1/10W
R1701	1-216-041-00	RES,CHIP 470 5%	1/10W	R1905	1-216-097-91	RES,CHIP 100K 5%	1/10W
R1702	1-216-025-91	RES,CHIP 100 5%	1/10W	R1906	1-216-073-00	RES,CHIP 10K 5%	1/10W
R1703	1-216-061-00	RES,CHIP 3.3K 5%	1/10W	R1907	1-216-097-91	RES,CHIP 100K 5%	1/10W
				R1908	1-216-033-00	RES,CHIP 220 5%	1/10W
				R1909	1-215-489-00	METAL 680K 1%	1/4W
				R1910	1-216-295-91	SHORT 0	
				R1911	1-216-073-00	RES,CHIP 10K 5%	1/10W

REF. NO.	PART. NO	DESCRIPTION	REMARK
----------	----------	-------------	--------

R1912	1-216-121-91	RES, CHIP	1M 5% 1/10W
R1913	1-216-049-91	RES, CHIP	1K 5% 1/10W
R1914	1-216-057-00	RES, CHIP	2.2K 5% 1/10W
R1915	1-216-065-91	RES, CHIP	4.7K 5% 1/10W
R1916	1-216-673-11	METAL CHIP	8.2K 0.50% 1/10W

R1917	1-216-693-11	METAL CHIP	56K 0.50% 1/10W
R1918	1-215-922-11	METAL OXIDE	6.8K 5% 3W F
R1921	1-215-922-11	METAL OXIDE	6.8K 5% 3W F
R1922	1-215-919-11	METAL OXIDE	2.2K 5% 3W F
R1923	1-216-097-91	RES, CHIP	100K 5% 1/10W

R1924	1-216-097-91	RES, CHIP	100K 5% 1/10W
R1925	1-216-097-91	RES, CHIP	100K 5% 1/10W
R1953	1-216-093-91	RES, CHIP	68K 5% 1/10W
R1954	1-216-109-00	RES, CHIP	330K 5% 1/10W
R1955	1-216-105-91	RES, CHIP	220K 5% 1/10W

R1956	1-216-123-11	RES, CHIP	1.2M 5% 1/10W
R1957	1-216-073-00	RES, CHIP	10K 5% 1/10W
R1958	1-216-025-91	RES, CHIP	100 5% 1/10W
R1959	1-216-063-91	RES, CHIP	3.9K 5% 1/10W
R1960	1-216-073-00	RES, CHIP	10K 5% 1/10W

R1961	1-216-687-11	METAL CHIP	33K 0.50% 1/10W
R1962	1-216-687-11	METAL CHIP	33K 0.50% 1/10W
R1964	1-216-025-91	RES, CHIP	100 5% 1/10W
R1965	1-216-041-00	RES, CHIP	470 5% 1/10W
R1966	1-215-886-11	METAL OXIDE	100 5% 2W F

R1968	1-215-886-11	METAL OXIDE	100 5% 2W F
R1969	1-216-485-11	METAL OXIDE	5.6K 5% 3W F

< TRANSFORMER >

T1901	1-424-584-11	TRANSFORMER, DYNAMIC FOCUS	
-------	--------------	----------------------------	--

**VM Board Variant Parts List KV-25FX20**

R1847	1-216-474-11	METAL OXIDE	82 5% 3W F
R1848	1-215-910-11	METAL OXIDE	68 5% 3W F
R1931	1-216-689-11	RES, CHIP	39K 5% 1/10W
R1967	1-216-485-11	METAL OXIDE	5.6K 5% 3W F

**VM Board Variant Parts List KV-29FX20**

R1847	1-215-911-21	METAL OXIDE	100 5% 3W F
R1848	1-216-475-21	METAL OXIDE	120 5% 3W F
R1931	1-216-089-71	RES, CHIP	47K 5% 1/10W
R1967	1-216-488-51	METAL OXIDE	18K 5% 3W F

REF. NO.	PART. NO	DESCRIPTION	REMARK
----------	----------	-------------	--------

**\*A-1646-184-A, H Board Complete**

< CAPACITOR >

C900	1-102-074-00	CERAMIC	0.001MF 10% 50V
C901	1-102-074-00	CERAMIC	0.001MF 10% 50V
C902	1-137-372-11	FILM	0.022MF 5% 50V
C903	1-137-372-11	FILM	0.022MF 5% 50V
C904	1-104-665-11	ELECT	100MF 20% 25V

C905	1-126-964-11	ELECT	10MF 20% 50V
C906	1-126-960-11	ELECT	1MF 20% 50V
C907	1-126-960-11	ELECT	1MF 20% 50V
C911	1-102-074-00	CERAMIC	0.001MF 10% 50V
C912	1-102-074-00	CERAMIC	0.001MF 10% 50V

< CONNECTOR >

CN900	1-779-947-11	TERMINAL BLOCK, S	
CN906	*1-564-511-11	PLUG, CONNECTOR 8P	
CN907	*1-568-882-51	PIN, CONNECTOR 7P	
CN908	*1-564-509-11	PLUG, CONNECTOR 6P	

< DIODE >

D901	8-719-030-11	DIODE SLA-570KT3F	
	4-203-258-01	HOLDER, LED (D901)	
D902	8-719-929-15	DIODE HZS9.1NB2	
D903	8-719-929-15	DIODE HZS9.1NB2	
D904	8-719-109-97	DIODE RD6.8ESB2	
D905	8-719-109-97	DIODE RD6.8ESB2	
D906	8-719-923-60	DIODE MTZJ-T-77-9.1A	
D907	8-719-923-60	DIODE MTZJ-T-77-9.1A	
D908	8-719-923-60	DIODE MTZJ-T-77-9.1A	

< IC >

IC900	8-742-014-11	HYB IC SBX1981-51	
-------	--------------	-------------------	--

< JACK SOCKET >

J900	1-750-264-11	JACK	
------	--------------	------	--

< COIL >

L900	1-412-531-31	INDUCTOR	33UH
L901	1-412-531-31	INDUCTOR	33UH
L902	1-408-603-31	INDUCTOR	10UH
L903	1-408-603-31	INDUCTOR	10UH

< RESISTOR >

R900	1-247-807-31	CARBON	100 5% 1/4W
R901	1-249-424-11	CARBON	3.9K 5% 1/4W

# H K S1

REF.NO.	PART.NO	DESCRIPTION	REMARK
R902	1-247-863-91	CARBON	22K 5% 1/4W
R903	1-247-701-11	CARBON	120 5% 1/4W
R904	1-247-701-11	CARBON	120 5% 1/4W
R908	1-249-401-11	CARBON	47 5% 1/4W
R909	1-247-895-91	CARBON	470K 5% 1/4W
R910	1-247-895-91	CARBON	470K 5% 1/4W
R911	1-535-303-00	LEAD, JUMPER (5.0MM)	
R912	1-249-417-11	CARBON	1K 5% 1/4W
R913	1-249-427-11	CARBON	6.8K 5% 1/4W
R914	1-249-429-11	CARBON	10K 5% 1/4W
R915	1-247-701-11	CARBON	120 5% 1/4W
R916	1-247-701-11	CARBON	120 5% 1/4W
R917	1-247-807-31	CARBON	100 5% 1/4W
R918	1-247-807-31	CARBON	100 5% 1/4W
< SWITCH >			
S900	1-692-979-21	SWITCH, TACTILE	
S901	1-692-979-21	SWITCH, TACTILE	
S902	1-692-979-21	SWITCH, TACTILE	
<b>*A-1649-023-A K Board, Complete</b>			
	7-682-148-01	SCREW +P 3X8	
< CAPACITOR >			
C281	1-126-960-91	ELECT	1MF 20% 50V
C282	1-126-943-31	ELECT	2200MF 20% 25V
C284	1-128-550-11	ELECT	2200MF 20% 50V
C285	1-126-943-31	ELECT	2200MF 20% 25V
C287	1-137-194-81	FILM	0.47MF 5% 50V
C288	1-136-165-00	FILM	0.1MF 5% 50V
C289	1-104-666-91	ELECT	220MF 20% 25V
C290	1-136-161-00	FILM	0.047MF 5% 50V
< CONNECTOR >			
CN225	*1-564-508-11	PLUG, CONNECTOR 5P	
CN282	*1-568-878-51	PIN, CONNECTOR 3P	
< DIODE >			
D201	8-719-911-19	DIODE 1SS119-25	
< IC >			
IC281	8-759-988-94	IC TDA2050	
< COIL >			
L281	1-406-973-41	INDUCTOR	22UH

REF.NO.	PART.NO	DESCRIPTION	REMARK
< TRANSISTOR >			
Q204	8-729-119-78	TRANSISTOR 2SC2785-HFE	
< RESISTOR >			
R201	1-247-865-91	CARBON	27K 5% 1/4W
R202	1-247-865-91	CARBON	27K 5% 1/4W
R203	1-247-895-91	CARBON	470K 5% 1/4W
R204	1-247-859-91	CARBON	15K 5% 1/4W
R205	1-247-859-91	CARBON	15K 5% 1/4W
R284	1-247-863-91	CARBON	22K 5% 1/4W
R285	1-249-438-11	CARBON	56K 5% 1/4W
R287	1-247-831-91	CARBON	1K 5% 1/4W
R288	1-216-353-00	METAL OXIDE	2.2 5% 1W F
R290	1-247-843-91	CARBON	3.3K 5% 1/4W
R292	1-247-843-91	CARBON	3.3K 5% 1/4W
R293	1-247-863-91	CARBON	22K 5% 1/4W
R294	1-247-829-91	CARBON	820 5% 1/4

**\*A-1654-041-A S1 Board, Complete**  
 (KV-25FX20A/25FX20D/25FX20R/  
 KV-29FX20A/29FX20D/29FX20R)

**\*A-1654-039-A S1 Board, Complete**  
 (KV-25FX20B/29FX20B)

**\*A-1654-040-A S1 Board, Complete**  
 (KV-25FX20E/25FX20K/  
 KV-29FX20E/29FX20K/29FX20U)

### S1 Board Common Parts

< CAPACITOR >			
C1103	1-163-021-91	CERAMIC CHIP	0.01MF 10% 50V
C1106	1-163-021-91	CERAMIC CHIP	0.01MF 10% 50V
C1107	1-163-021-91	CERAMIC CHIP	0.01MF 10% 50V
C1108	1-163-021-91	CERAMIC CHIP	0.01MF 10% 50V
C1109	1-104-664-11	ELECT	47MF 20% 25V
C1110	1-126-960-11	ELECT	1MF 20% 50V
C1111	1-126-960-11	ELECT	1MF 20% 50V
C1113	1-104-664-11	ELECT	47MF 20% 25V
C1115	1-104-664-11	ELECT	47MF 20% 25V
C1116	1-163-021-91	CERAMIC CHIP	0.01MF 10% 50V
C1117	1-163-021-91	CERAMIC CHIP	0.01MF 10% 50V
C1118	1-164-005-11	CERAMIC CHIP	0.47MF 25V
C1119	1-126-960-11	ELECT	1MF 20% 50V
C1120	1-164-005-11	CERAMIC CHIP	0.47MF 25V
C1122	1-104-664-11	ELECT	47MF 20% 25V
C1123	1-163-038-91	CERAMIC CHIP	0.1MF 25V
C1124	1-163-251-11	CERAMIC CHIP	100PF 5% 50V
C1127	1-126-960-11	ELECT	1MF 20% 50V
C1128	1-126-960-11	ELECT	1MF 20% 50V

REF. NO.	PART.NO	DESCRIPTION	REMARK	REF. NO.	PART.NO	DESCRIPTION	REMARK
C1129	1-126-960-11	ELECT	1MF	20%	50V		
C1130	1-126-964-11	ELECT	10MF	20%	50V		
C1132	1-104-664-11	ELECT	47MF	20%	25V		
C1133	1-163-038-91	CERAMIC CHIP	0.1MF		25V		
C1134	1-126-964-11	ELECT	10MF	20%	50V		
C1136	1-126-964-11	ELECT	10MF	20%	50V		
C1139	1-126-964-11	ELECT	10MF	20%	50V		
C1143	1-163-021-91	CERAMIC CHIP	0.01MF	10%	50V		
C1144	1-163-021-91	CERAMIC CHIP	0.01MF	10%	50V		
C1145	1-163-038-91	CERAMIC CHIP	0.1MF		25V		
C1146	1-164-005-11	CERAMIC CHIP	0.47MF		25V		
C1147	1-164-005-11	CERAMIC CHIP	0.47MF		25V		
C1148	1-164-005-11	CERAMIC CHIP	0.47MF		25V		
C1149	1-126-960-11	ELECT	1MF	20%	50V		
C1150	1-126-960-11	ELECT	1MF	20%	50V		
C1151	1-104-664-11	ELECT	47MF	20%	25V		
C1152	1-163-038-91	CERAMIC CHIP	0.1MF		25V		
< CONNECTOR >							
CN1101*	1-766-954-11	CONNECTOR, BOARD TO BOARD	20P				
< FERRITE BEAD >							
FB1101	1-410-396-41	FERRITE	0.45UH				
FB1102	1-410-396-41	FERRITE	0.45UH				
FB1104	1-410-396-41	FERRITE	0.45UH				
FB1110	1-412-002-31	INDUCTOR CHIP	4.7UH				
FB1111	1-412-002-31	INDUCTOR CHIP	4.7UH				
FB1112	1-412-002-31	INDUCTOR CHIP	4.7UH				
< IC >							
IC1102	8-759-100-96	IC	UPC4558G2				
IC1103	8-759-394-57	IC	PST593C-MMP-4P				
< COIL >							
L1114	1-410-671-31	INDUCTOR	47UH				
L1115	1-408-599-31	INDUCTOR	4.7UH				
L1116	1-408-599-31	INDUCTOR	4.7UH				
< RESISTOR >							
R1101	1-216-073-00	RES,CHIP	10K	5%	1/10W		
R1102	1-216-073-00	RES,CHIP	10K	5%	1/10W		
R1105	1-216-035-00	RES,CHIP	270	5%	1/10W		
R1110	1-216-025-91	RES,CHIP	100	5%	1/10W		
R1111	1-216-025-91	RES,CHIP	100	5%	1/10W		
R1113	1-216-073-00	RES,CHIP	10K	5%	1/10W		
R1121	1-216-065-91	RES,CHIP	4.7K	5%	1/10W		
R1122	1-216-065-91	RES,CHIP	4.7K	5%	1/10W		
R1123	1-216-218-00	RES,CHIP	6.8K	5%	1/8W		
R1124	1-216-073-00	RES,CHIP	10K	5%	1/10W		
R1125	1-216-069-00	RES,CHIP	6.8K	5%	1/10W		
R1126	1-216-073-00	RES,CHIP	10K	5%	1/10W		
R1155	1-216-085-00	RES,CHIP	33K	5%	1/10W		
R1156	1-216-085-00	RES,CHIP	33K	5%	1/10W		
R1174	1-216-085-00	RES,CHIP	33K	5%	1/10W		
R1175	1-216-085-00	RES,CHIP	33K	5%	1/10W		
R1176	1-216-085-00	RES,CHIP	33K	5%	1/10W		
R1177	1-216-085-00	RES,CHIP	33K	5%	1/10W		
R1178	1-216-073-00	RES,CHIP	10K	5%	1/10W		
< CRYSTAL >							
X1101	1-767-813-21	VIBRATOR, CRYSTAL					
<b>S1 Board Variant Parts</b>							
KV-25FX20A/25FX20D/25FX20R/ KV-29FX20A/29FX20D/29FX20R							
< IC >							
IC1101	8-759-574-73	IC	TDA9875A				
< RESISTOR >							
R1165	1-216-295-91	SHORT	0				
<b>S1 Board Variant Parts</b>							
KV-25FX20B/29FX20B							
< CAPACITOR >							
C1131	1-164-005-11	CERAMIC CHIP	0.47MF		25V		
C1135	1-163-251-11	CERAMIC CHIP	100PF	5%	50V		
C1137	1-104-664-11	ELECT	47MF	20%	25V		
C1138	1-163-251-11	CERAMIC CHIP	100PF	5%	50V		
< FILTER >							
CF1101	1-409-327-00	TRAP, CERAMIC	(6.5MHZ)				
< FERRITE BEAD >							
FB1113	1-412-002-31	INDUCTOR CHIP	4.7UH				
< IC >							
IC1101	8-759-574-73	IC	TDA9875A				
< COIL >							
L1113	1-408-600-31	INDUCTOR	5.6UH				

**S1**

The components identified by shading and marked  $\Delta$  are critical for safety  
Replace only with the part number specified.

REF. NO.	PART. NO	DESCRIPTION	REMARK
L1117	1-410-671-31	INDUCTOR 47UH	
< TRANSISTOR >			
Q1112	8-729-120-28	TRANSISTOR 2SC1623-L5L6	
Q1113	8-729-120-28	TRANSISTOR 2SC1623-L5L6	
Q1114	8-729-216-22	TRANSISTOR 2SA1162-G	
Q1115	8-729-120-28	TRANSISTOR 2SC1623-L5L6	
< RESISTOR >			
R1108	1-216-077-00	RES,CHIP 15K 5% 1/10W	
R1152	1-216-035-00	RES,CHIP 270 5% 1/10W	
R1153	1-216-025-91	RES,CHIP 100 5% 1/10W	
R1154	1-216-067-00	RES,CHIP 5.6K 5% 1/10W	
R1160	1-216-081-00	RES,CHIP 22K 5% 1/10W	
R1161	1-216-041-00	RES,CHIP 470 5% 1/10W	
R1162	1-216-061-00	RES,CHIP 3.3K 5% 1/10W	
R1163	1-216-081-00	RES,CHIP 22K 5% 1/10W	
R1164	1-216-073-00	RES,CHIP 10K 5% 1/10W	
R1167	1-216-025-91	RES,CHIP 100 5% 1/10W	
R1168	1-216-033-00	RES,CHIP 220 5% 1/10W	
R1169	1-216-049-91	RES,CHIP 1K 5% 1/10W	
R1170	1-216-001-00	RES,CHIP 10 5% 1/10W	
R1171	1-216-045-00	RES,CHIP 680 5% 1/10W	
R1172	1-216-041-00	RES,CHIP 470 5% 1/10W	
R1173	1-216-049-91	RES,CHIP 1K 5% 1/10W	

**S1 Board Variant Parts**

**KV-25FX20E/25FX20K  
KV-29FX20E/29FX20K/29FX20U**

&lt; IC &gt;

IC1101 8-759-574-73 IC TDA9875A

&lt; RESISTOR &gt;

R1164 1-216-073-00 RES,CHIP 10K 5% 1/10W

**MISCELLANEOUS**

E 1-419-142-11 COIL, DEGAUSING (25")

E 1-416-654-11 COIL, DEMAGNETIC (29")

1-452-032-00 MAGNET, DISC; 10MM

1-452-094-00 MAGNET, ROTATABLE DISK; 15MM

E 8-453-011-11 NECK ASSY, NA299-M

E 1-453-308-11 TRANSFORMER ASSY, FLYBACK (NX-4521/U2B4)

1-529-417-11 SPEAKER 8CM

1-529-408-11 LOUD SPEAKER 4.2x20CM

E 1-251-317-31 CAP ASSY, HIGH-VOLTAGE

E 1-762-087-11 SWITCH, PUSH (AC POWER)

REF. NO.	PART. NO	DESCRIPTION	REMARK
E 1-765-286-11	CORD, POWER (KV-25FX20/29FX20A/29FX20B/ KV-29FX20D/29FX20E/29FX20K/ KV-29FX20R)		
E 1-776-860-12	CORD POWER, FILTER UK (KV-29FX20U)		
8-598-432-00	TUNER (BTP-AC411) (KV-25FX20A/25FX20D/25FX20E/25FX20K/25FX20R KV-29FX20A/29FX20D/29FX20E/29FX20K/29FX20R)		
1-693-418-11	TUNER (TELE9-001A) (KV-25FX20B/29FX20B)		
8-598-464-00	TUNER (BTP-AU611) (KV-29FX20U)		
E 8-733-250-05	PICTURE TUBE (A60LPN70X) (25")		
E 8-735-053-05	PICTURE TUBE (M68LNH060X) (29")		
E 1-451-475-11	DEFLECTION YOKE (Y25RSA) (KV-25FX20)		
E 8-451-494-21	DEFLECTION YOKE (Y29RSA-M2) (KV-29FX20)		

**ACCESSORIES AND PACKAGING MATERIALS**

\*4-042-476-01 BAG, PROTECTION (25")

\*4-029-168-01 BAG, PROTECTION (29")

\*4-204-811-01 INDIVIDUAL CARTON (25")

\*4-204-784-01 INDIVIDUAL CARTON (29")

\*4-204-810-01 CUSHION (UPPER) (ASSY) (25")

\*4-204-780-01 CUSHION (UPPER) (ASSY) (29")

\*4-204-807-01 CUSHION (LOWER) (ASSY) (25")

\*4-204-783-01 CUSHION (LOWER) (ASSY) (29")

\*4-204-787-41 MANUAL INSTRUCTION (KV-25FX20A/29FX20A)  
(ITALIAN)\*4-204-787-51 MANUAL INSTRUCTION (KV-25FX20B/29FX20B)  
(FRENCH/ITALIAN/GERMAN/DUTCH)\*4-204-787-11 MANUAL INSTRUCTION (KV-25FX20D/29FX20D)  
(ENGLISH/GERMAN/GREEK/TURKISH)4-204-787-71 MANUAL INSTRUCTION (KV-25FX20E/29FX20E)  
(SPANISH)4-204-787-81 MANUAL INSTRUCTION (KV-25FX20E/29FX20E)  
(FINNISH/NORWEGIAN/HUNGARIAN/PORTUGUESE/  
DANISH/SWEDISH)4-204-787-91 MANUAL INSTRUCTION (KV-25FX20K/29FX20K)  
(ENGLISH/CZECH/POLISH/HUNGARIAN/SLOVAKIAN)4-204-788-91 MANUAL INSTRUCTION (KV-25FX20R/29FX20R)  
(ENGLISH/RUSSIAN/BULGARIAN)4-204-787-61 MANUAL INSTRUCTION (KV-29FX20U)  
(ENGLISH)**REMOTE COMMANDER**

1-418-476-11 REMOTE COMMANDER (RM-887)





